

1-1-2014

A Novel Function For 12-Lipoxygenase In C-Met And Integrin β 4 Axis Crosstalk

Elizabeth Tovar
Wayne State University,

Follow this and additional works at: http://digitalcommons.wayne.edu/oa_dissertations

 Part of the [Cell Biology Commons](#), and the [Molecular Biology Commons](#)

Recommended Citation

Tovar, Elizabeth, "A Novel Function For 12-Lipoxygenase In C-Met And Integrin β 4 Axis Crosstalk" (2014). *Wayne State University Dissertations*. Paper 1029.

This Open Access Dissertation is brought to you for free and open access by DigitalCommons@WayneState. It has been accepted for inclusion in Wayne State University Dissertations by an authorized administrator of DigitalCommons@WayneState.

**A NOVEL FUNCTION FOR 12-LIPOXYGENASE IN C-MET AND INTEGRIN β 4 AXIS
CROSSTALK**

by

ELIZABETH TOVAR

DISSERTATION

Submitted to the Graduate School

of Wayne State University,

Detroit, Michigan

in partial fulfillment of the requirements

for the degree of

DOCTOR OF PHILOSOPHY

2014

MAJOR: CANCER BIOLOGY

Approved by:

Advisor

Date

**© COPYRIGHT BY
ELIZABETH TOVAR
2014
ALL RIGHTS RESERVED**

DEDICATION

I would like to dedicate this dissertation to those whom I love who have battled cancer. Many of you have lost your life to this horrible disease. Some of you still live and serve as a daily reminder why I went into cancer research in the first place. All of you have been my constant inspiration these past five years in graduate school. Looking forward, I promise I will do my best to contribute to the advancements in this field for you and anyone else who has lost someone to cancer. I will never forget you.

ACKNOWLEDGMENTS

There are so many wonderful people I have to acknowledge for the fulfillment of this dissertation. First I must give many thanks to my mentor Dr. Kenneth V. Honn, without whom I wouldn't have grown into an independent scientist with a natural inclination to question everything. Dr. Honn allowed me to develop and guide my project with minimal (but invaluable) oversight and for that I will be forever grateful. I had to learn, sometimes the hard way, experimental design and execution, but because of that I'm now an expert at problem solving with refined lab skills combined with mastery of many techniques. He consistently evaluated my work with a critical eye in a constructive manner, always reminding me that persistence is the key to scientific success. Even though my experiments rarely ever worked the first time, Dr. Honn was extremely supportive and offered many suggestions. He sent me to numerous conferences, both national and international, helped me submit grant applications, and helped me apply for multiple internal funding sources. Dr. Honn also trusted me to independently write research articles and a review. Thank you, again, Dr. Honn, for your support and guidance.

Thank you to all my committee members, Dr. Shijie Sheng, Dr. Todd Leff, and Dr. Julie Boerner for all your suggestions and evaluations of my research. You spent hours of your own valuable time so that I could learn to be a better scientist. I appreciate your enthusiasm when it comes to science and I hope to carry that with me into my future career. Special thanks to Dr. Boerner for being such an excellent student advocate. She always gave me great advice.

Thanks to Dr. Stephanie Tucker, research associate for Dr. Honn in the Department of Pathology at Wayne State University and also to Dr. Rao Maddipati, from the Lipidomics Core at Wayne State University. Dr. Tucker encouraged me to think 'outside the box' and was always available if I needed help with the many aspects of graduate school (political, scientific, personal). She spent hours poring over my research presentations, helped with experimental design, guided

several of my funding applications, gave me literally hundreds of publications to read as ‘homework’ (which I greatly appreciate!), and was a friend I could talk to in lab. Thanks again Stephanie. Dr. Maddipati helped problem solve all my lipid extraction protocols and also invested time editing my posters for the Bioactive Lipids Conferences. I probably wouldn’t have successfully extracted any lipids at if it weren’t for Dr. Maddipati’s assistant, Dr. Sen-Lin Zhou. Thanks for always politely answering the gazillion questions about extraction procedures I had.

Thanks to the Graduate Program in Cancer Biology, especially Dr. Larry Matherly and Dr. George Brush. The program has given me many opportunities to collaborate, network, and learn with other scientists. Thank you for choosing me as a T32 recipient. It is an honor to represent our program. Thanks as well to the program administrators I had the pleasure of working with: Lannette Rowland, Jill DeJesus, and Nadia Daniel.

Thanks to all of Dr. Honn’s lab members, both past and present. I would specifically like to thank Dr. Yinlong Cai, our lab manager, and Christopher Harris, our administrator. Yinlong always had a suggestion or way to save money for each experiment. He also kept the lab interesting, sometimes yelling at the top of his lungs *jokingly* with Senlin or telling fun stories. Chris has advice for almost any situation you can think of and liked to stop by my desk every day to say hello. I will miss their friendship.

Many thanks go out to the friends I made at Wayne State. Without you I wouldn’t have any sanity left. Our Thursday post-seminar lunches always gave me something to look forward to during the week. Thank you a million times over to Dr. Sara Schmitt, my closest friend and colleague. She’s become like a sister to me and I’m very lucky to have gained a true friend for life.

The people I have to thank the most for accomplishing my goal of earning a PhD are my family members, each and every single one of them. My older brother Adam and his wife Kassie

provided me endless encouragement and support in my graduate school journey. It was comforting to know I had rock solid people like them to depend on if I ever needed anything. My younger brother Tim and his wife Christine constantly reassured me that I was on the right path and believed in me even when I didn't. My husband's family, Rosa, Victor, Janeth, Moises, Gabriel, and Jasmine stood behind me no matter what. My parents, Dave and Terrie Martens, are my role models. They showed me what hard work and dedication looks like and inspire me every day to fight, through research, for cancer survivors like them. I'm so proud of my dad who recently battled and defeated prostate cancer. Both of my parents are incredibly strong people with huge hearts. And they have supported every decision I've made, happily obliging to parent a 'professional student' and co-sign their lives away in student loans. I can only wish to be their equal someday.

My biggest thank you goes out to my husband, Marcos. He has supported me these last five years in ways many people would not understand. When I told him I wanted to go to graduate school at Wayne State University, he agreed that I should follow my dreams, even at the expense of our relationship. We've spent these last five years living separately, him in Grand Rapids and me in Farmington Hills, commuting two hours each way every weekend to see each other. That was not easy to deal with. I'm so grateful and so blessed to have him in my life. He's been exceptionally understanding of all my frustrations with graduate school and was always there cheer me on when I felt discouraged. Thank you for loving me, I literally would not be writing this without you. You mean the world to me.

TABLE OF CONTENTS

Dedication	ii
Acknowledgments	iii
List of Figures	viii
List of Tables	xi
Chapter 1. The Orchestration of 12-Lipoxygenase, Integrin β 4, and c-Met Signaling in Cancer Cell Invasion and Metastasis	1
Introduction	1
Dietary Lipid Intake and Cancer Progression	1
Cellular Lipid Metabolism	2
The Lipoxygenase Family of Lipid Enzymes	5
12-Lipoxygenase	7
Integrin β 4 regulation of 12-Lipoxygenase	13
Integrin β 4 Function in Hemidesmosomes and Cell Motility	28
Integrin β 4 and 12-Lipoxygenase are required for HGF-induced PC-3 Prostate Cancer Cell Invasion	37
c-Met Receptor Tyrosine Kinase	39
History of Integrin β 4 and c-Met Association: Interaction and Functional Significance	44
Hypothesis	47
Chapter 2. Materials and Methods	49
Chapter 3. A Novel Function for 12-Lipoxygenase in c-Met and Integrin β 4 Axis Cross-talk: Interaction and Functional Studies	57
A431 Epidermoid Carcinoma Results	57
Prostate Cancer Cell Line Results	95
Chapter 4. Discussion	120

References	131
Abstract	161
Autobiographical Statement	163

LIST OF FIGURES

Figure 1. Arachidonic Acid Metabolism_____	4
Figure 2. Lipoxygenase Metabolism of Arachidonic Acid_____	6
Figure 3. 12-LOX Metabolism of Arachidonic Acid_____	8
Figure 4. Activation of 12HETER-1 by 12(S)-HETE_____	11
Figure 5. Hypothetical Implications of 12-LOX Interaction with β 4_____	14
Figure 6. LC-MS Analysis of 12(S)-HETE Production Following β 4 Stimulation_____	17
Figure 7. Validation of 12-LOX Knockdown_____	20
Figure 8. 12-LOX Knockdown Inhibits β 4-mediated 12(S)-HETE Production and Downstream ERK Activation_____	22
Figure 9. 12-LOX Knockdown Renders Cells Resistant to BMD122-inhibited Invasion and Non-responsive to EGF-stimulated Invasion_____	24
Figure 10. Schematic of 12-LOX Interaction with β 4_____	27
Figure 11. β 4 Plays a Role in Hemidesmosomes in Stably Adherent Cells While Assisting in Cell Signaling and Migration Following Activation_____	30
Figure 12. The Cytoplasmic Tail of β 4 and 12-LOX are Required for PC-3 Prostate Cancer Cell Invasion_____	38
Figure 13. c-Met Signaling Axis_____	41
Figure 14. Hypothesis_____	48
Figure 15. HGF Stimulation Disrupts the β 4/c-Met Association_____	59
Figure 16. HGF Stimulation Disrupts the β 4/c-Met Association and Leads to Disassembly of Hemidesmosome-like Structures_____	61
Figure 17. HGF Stimulation Leads to β 4 Phosphorylation_____	67
Figure 18. The c-Met Inhibitor INC280 Reveals HGF Activation of c-Met Leads to β 4 Activation_____	69
Figure 19. Schematic of 12-LOX Activation Following β 4 Stimulation_____	71

Figure 20. HGF Stimulation Leads to 12-LOX Recruitment to β 4	72
Figure 21. HGF Stimulation Does Not Result in 12-LOX Enzymatic Activation	75
Figure 22. Confirmation of 12-LOX Knockdown	77
Figure 23. 12-LOX is Required for HGF-induced β 4 Phosphorylation and Downstream Signaling	79
Figure 24. 12-LOX is Not Required for β 4 and c-Met Association	81
Figure 25. 12-LOX Regulates HGF-induced Cell Scatter and Invasion	84
Figure 26. FNO1 and FNO1-2 Peptides Decrease β 4 and 12-LOX Interaction	87
Figure 27. FNO1 and FNO1-2 Peptides Suppress HGF-induced β 4 Phosphorylation and Downstream Signaling	88
Figure 28. Inhibition of β 4 and 12-LOX Interaction, by FNO1 or FNO1-2 Peptides, Decreased HGF-induced Cell Scattering and Invasion	90
Figure 29. 12-LOX Acts as a Scaffold to Enhance c-Met Mediated Cell Scattering and Invasion	94
Figure 30. HGF-Stimulation Does Not Disrupt β 4 and c-Met Association in PC-3M Prostate Cancer Cells	97
Figure 31. HGF-Stimulation Does Not Disrupt β 4 and c-Met Association in PC-3, PC-3 12-LOX Overexpressing, or PC-3 Empty Vector Prostate Cancer Cells	98
Figure 32. Confocal Immunofluorescence Confirms that HGF Does Not Affect β 4 and c-Met Co-localization in PC-3M Prostate Cancer Cells and that Prostate Cancer Cells do not Form Hemidesmosomes	100
Figure 33. HGF Stimulation Results in β 4 Phosphorylation in PC-3M Prostate Cancer Cells	103
Figure 34. HGF Stimulation Does Not Result in β 4-Y1494 Phosphorylation in PC-3M Prostate Cancer Cells	105
Figure 35. HGF Stimulation Leads to 12-LOX Recruitment to β 4 in PC-3M Prostate Cancer Cells	107
Figure 36. Inhibition of 12-LOX Enzymatic Activity Reduces HGF-induced Invasion and is Not Rescued by 12(S)-HETE in PC-3M Prostate Cancer Cells	109

Figure 37. Inhibition of 12-LOX Enzymatic Activity Reduces HGF-induced Invasion and is Not Rescued by 12(S)-HETE in DU145 Prostate Cancer Cells_____	110
Figure 38. 12HETER-1 Does Not Play a Role in HGF-induced Invasion in PC-3M Prostate Cancer Cells_____	112
Figure 39. 12-LOX Enzymatic Inhibition Does Not Affect β 4 and c-Met Constitutive Association of c-Met Activation with HGF_____	114
Figure 40. 12-LOX Enzymatic Inhibition Does Not Affect HGF-induced Cellular Adhesion_	115
Figure 41. HGF Stimulation Does Not Increase 12(S)-HETE Production_____	117
Figure 42. 12-LOX Acts as a Scaffold to Regulate β 4-enhanced c-Met-mediated Prostate Cancer Cell Invasion_____	119

LIST OF TABLES

Table 1. Sequences of shRNA Constructs Targeting 12-LOX_____19

CHAPTER 1. THE ORCHESTRATION OF 12-LIPOXYGENASE, INTEGRIN β 4, AND C-MET SIGNALING IN CANCER CELL INVASION AND METASTASIS

Introduction

Hematogenous metastasis presents the single most devastating occurrence to patient prognosis and survival. Unraveling this multi-dimensional mechanism is the key to understanding how to defeat the disease. While astounding progress has been made in this field over the last decade, there is still much to discover. The issue is that metastasis is not as simple as cell migration. It must be studied in the context of tissue microenvironment, immune regulation, environmental variables, epigenetics, etc., combined with the thousands of other variables which influence cancer cell invasion. The metastatic cascade consists of multiple, well-defined steps that involve the morphological epithelial to mesenchymal transition (EMT), which allows cells to detach from their primary location, elongate to invade through the surrounding tissue matrix via remodeling or degradation of the basement membrane architecture, and eventually culminate in the colonization of a distant secondary site. Throughout this journey, tumor cells are selected for survival while traversing hostile, foreign micro-environments, and outside their tissue of origin at the metastatic site, must be able to initiate angiogenesis to protect against apoptosis. Each step, or a combination of them, can be controlled in part by three different proteins: c-Met, integrin β 4, and 12-Lipoxygenase.

Dietary Lipid Intake and Cancer Progression

Extensive research has been carried out concerning the effect of dietary omega-3 (n-3) to omega-6 (n-6) fatty acid ratios and the risk these ratios pose to cancer development. There are numerous epidemiological studies that suggest diets high in n-6 consumption increase the risk of developing cancer (de Lorgeril & Salen 2012; de Lorgeril et al. 1998; Kolonel 2001; Pearce & Dayton 1971). For example, meta-analysis of multiple independent breast cancer cohort studies

found dietary n-3 intake inversely associated with breast cancer risk and that this effect was more robust in women from Asian countries compared to Western populations (Yang et al. 2014). While that study does not show directly that an increase in n-6 fatty acids increases the risk of developing breast cancer, it is notable that western diets are largely composed of foods rich in n-6 poly-unsaturated fatty acids, including red meats, dairy products, and eggs. The most predominant n-6 fatty acid is arachidonic acid (AA), an essential fatty acid in mammals, meaning we acquire it strictly through dietary means. It has been demonstrated that elevated levels of AA lead to malignant gliomas (Elsherbiny et al. 2013).

Another correlation of fatty acids with the promotion of tumorigenesis can be found in prostate cancer. A 12 year prospective study of 47,882 men found diets with increased fish consumption (n-3) were positively correlated with a decreased risk of metastatic prostate cancer (Augustsson et al. 2003), whereas red meat consumption was found to be a risk factor for prostate cancer (Norrish et al. 1999). Additionally, in a mouse model of prostate cancer, increasing n-6 intake accelerated tumor growth compared to mice on an n-3 or low n-6 diet (Berquin et al. 2007). Interestingly, the mortality rate of prostate cancer is considerably higher in Europe and the USA compared to Japan and Asia, while immigrants from Asian countries have an increased risk of developing the disease if they relocate to the USA, presumably due to their adaptation to an n-6 rich Western diet (Haenszel & Kurihara 1968; Wynder et al. 1971).

Cellular Lipid Metabolism

As noted, AA is the most predominant poly-unsaturated fatty acid and is acquired through dietary intake as mammals cannot synthesize it *de novo*. Linoleic acid is a major dietary precursor of AA and is elongated and desaturated, by multiple desaturase and elongase enzymes, from a C-18 fatty acid to AA. Once absorbed into the bloodstream, AA is delivered to cells via chylomicrons

and esterified by fatty-acylCoA synthetase to membrane phospholipids such as phosphatidylethanolamine, phosphatidylcholine, and phosphatidylinositol. Chylomicrons are lipoprotein particles that carry triglycerides, phospholipids, cholesterol, and proteins from the intestines to other parts of the body. To be metabolized, AA must be cleaved from the phospholipid membrane. This can occur directly through phospholipase A2 (PLA2) or indirectly through phospholipase C (PLC) cleavage of diacylglycerol (DAG), which is subsequently cleaved by DAG lipase to yield AA (Figure 1) (Needleman et al. 1986). Once free within the cell, AA is metabolized by one of three different pathways: cyclooxygenase, cytochrome p450 epoxygenase, or the lipoxygenase pathways (Needleman et al. 1986; Serhan 1994; Spector et al. 1988). Activation of these pathways results in the production of bioactive lipid products collectively called eicosanoids, which function in diverse homeostatic biological roles, including, but not limited to, cell growth, apoptosis, adhesion, immunity, cellular adhesion, blood clot formation, and inflammation (Montero et al. 2003; Nie et al. 2001; Nie & Honn 2002; Pidgeon et al. 2007).

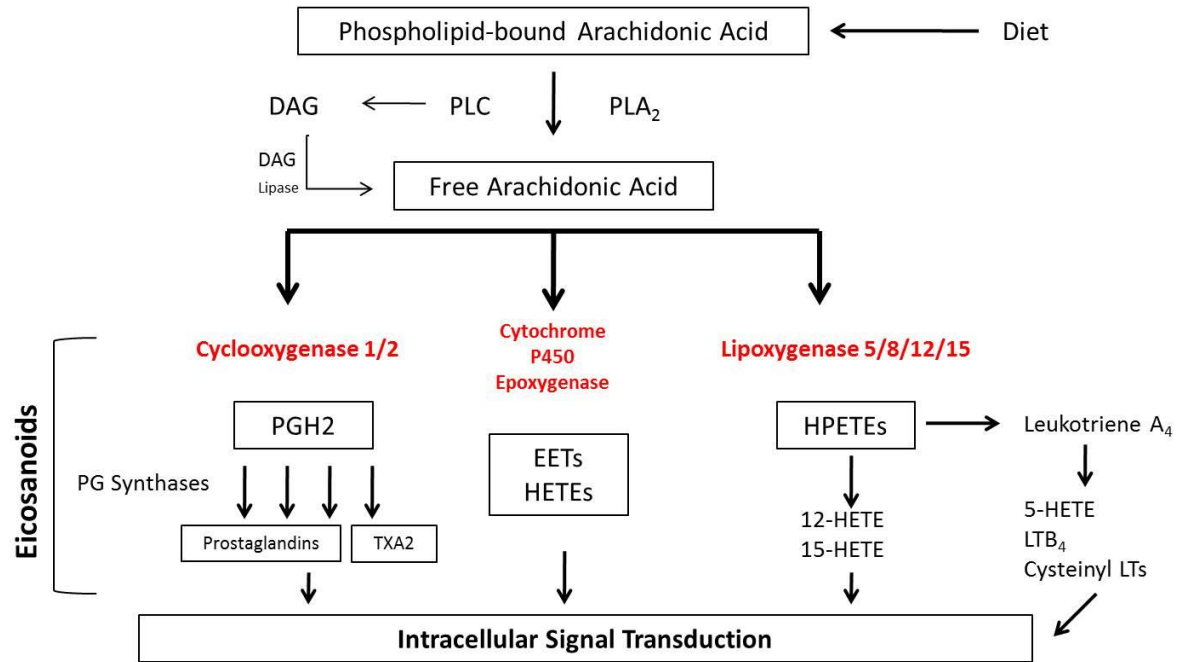

Figure 1. Arachidonic Acid Metabolism. Using AA as a substrate, COX1/2 enzymes produce PGG₂ and PGH₂, which get converted into prostaglandins, prostacyclins, and thromboxanes. Lipoxygenases produce various HPETE products that are converted into HETEs, lipoxins, leukotrienes, hexoxilins, and jasmonates. The cytochrome P450 epoxygenases produce epoxy eicosatetraenoic acids (E_pET_{rE}). All of these products are collectively called eicosanoids and activate cell signaling. Modified from two sources: Pidgeon et al. 2007. Lipoxygenase Metabolism: Roles in Tumor Progression and Survival. *Cancer and Metastasis Reviews* 26, 503-524 and Patel et al. 2008. The Arachidonic Acid Pathway and its Role in Prostate Cancer Development and Progression. *Journal of Urology* 179, 1668-1675.

The Lipoxygenase Family of Lipid Enzymes

Lipoxygenases are a family of non-heme iron dioxygenases that catalyze the addition of oxygen onto AA with regional and isomeric cis/trans configuration specificity and are named as such (Figure 2) (Brash 1999; Shimizu & Wolfe 1990). These lipid enzymes have dual oxygenase and lipoxin functions that lead to the production of unstable hydroperoxyeicosatetraenoic acids (HPETEs) that are reduced to hydroxyeicosatetraenoic acids (HETEs), leukotrienes, lipoxins, jasmonates and hepoxilins (Needleman et al. 1986; Nie et al. 2001; Romano et al. 1993; Spector et al. 1988). The lipoxygenase (LOX) family is composed of three major lipoxygenases identified in mammals, including 5-, 15-, and 12-lipoxygenase (Brash 1999). It is believed that 5-LOX, 12-LOX and 15-LOX-1 are pro-tumorigenic as they are all upregulated in the initiation and progression of cancer, while the role of 15-LOX-2 is controversial (Pidgeon et al. 2007).

5-LOX catalyzes the conversion of AA into 5-HPETE, which is then converted into 5-HETE or leukotriene A₄ (LTA₄) (Samuelsson 1983). LTA₄ can then be converted further into LTB₄, LTC₄, LTD₄, or LTE₄, products that are known to regulate anaphalaxis (Piper 1985). 15-LOX-1 produces 15(S)-HETE from AA and 13(S)-HODE from linoleic acid (Pidgeon et al. 2007). 13(S)-HODE is a lipid product observed to antagonize 12-LOX pro-tumorigenic function in cancer cells (Liu et al. 1995). 15-LOX-2 metabolizes linoleic acid poorly and like 15LOX-1, produces 15(S)-HETE from AA. 12-LOX can be classified further by the existence of three isoforms named after their tissue of predominant expression: platelet, leukocyte, and epithelium (Yamamoto 1992). Each isoform has different substrate selectivity and metabolic profiles but, it is platelet 12-LOX that is associated with tumor progression.

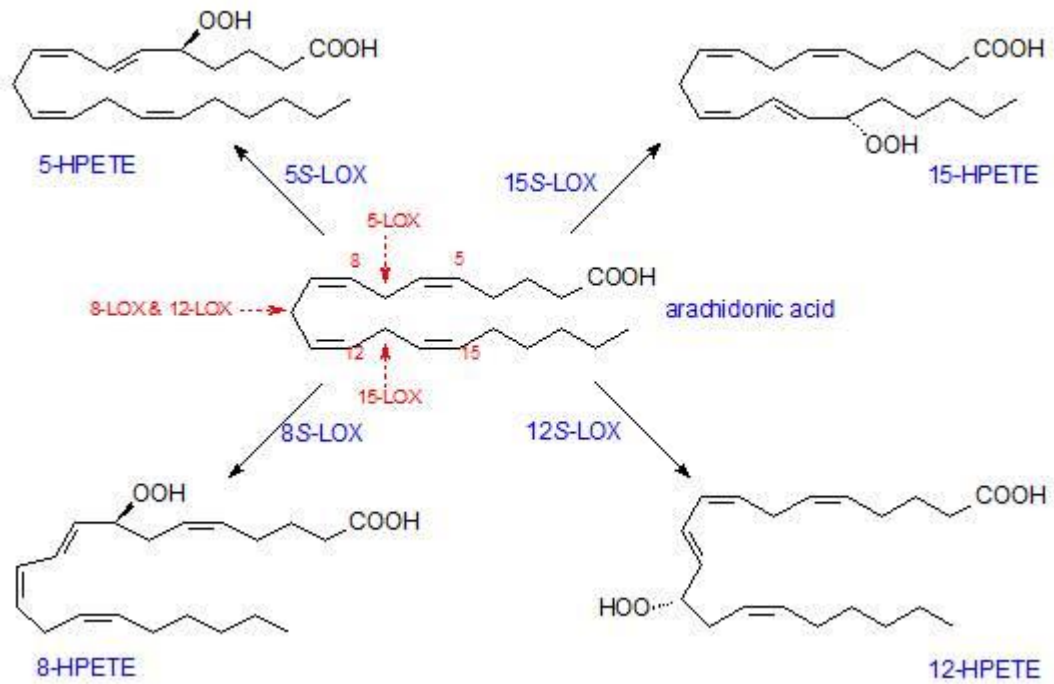

Figure 2. Lipoxygenase Metabolism of Arachidonic Acid. 5-LOX, 8-LOX, 12-LOX, and 15-LOX insert oxygen into AA with regional and stereo-specificity to yield bioactive lipid products called eicosanoids. From lipidlibrary.aocs.org.

12-Lipoxygenase

12-Lipoxygenase Isoforms: Leukocyte, Epithelium, and Platelet

Leukocyte 12-LOX was cloned from porcine leukocytes and is found expressed in human adrenal glomerulosa cells (Gu et al. 1994; Yoshimoto 1982). This enzyme converts AA or linoleic acid into 12(S)-HETE, 11-HETE, and 15(S)-HETE (Limor 2001). Epithelium 12-LOX was cloned from bovine tracheal epithelial cells and is found expressed in rat brain and human epithelial tissue (De Marzo et al. 1992). In humans, this isoform converts AA into the 12(R)-HETE enantiomer (Boeglin et al. 1998). Both leukocyte and epithelium type 12-LOX are more similar genetically to human and rabbit 15-LOX than to platelet 12-LOX (Yoshimoto et al. 1992). Human platelet 12-LOX was cloned from erythroleukemia cells (Funk et al. 1990) and converts AA into 12-HPETE via insertion of molecular oxygen into the carbon-12 position of the fatty acid (Figure 3). The resultant unstable HPETE intermediate is then reduced by glutathione peroxidases to the stereoisomeric 12(S)-HETE product (Brash 1999; Samuelsson 1983). Platelet 12-LOX also converts leukotriene A₄ during platelet-leukocyte interactions into the anti-inflammatory mediators lipoxin A₄ and B₄ (Romano et al. 1993). Because the platelet 12-LOX isoform is associated with tumor progression, it is the focus of this dissertation and will hereafter be referred to as simply 12-LOX.

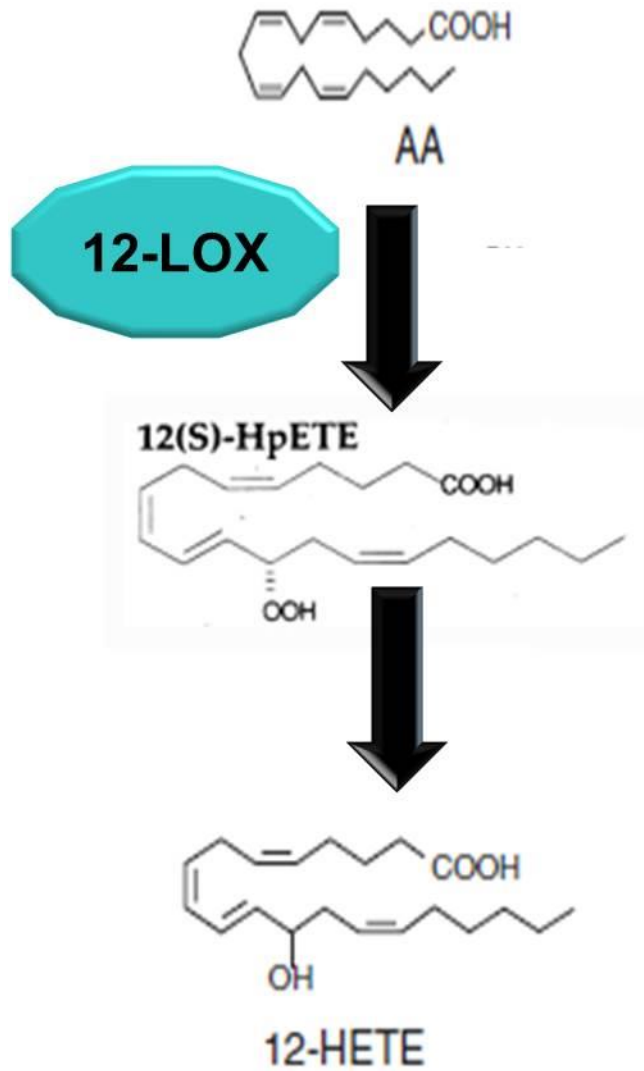

Figure 3. 12-LOX Metabolism of Arachidonic Acid. 12-LOX enzymatically catalyzes the addition of molecular oxygen onto the carbon backbone of AA to yield the 12(S)-HPETE intermediate. This product is then reduced by glutathione peroxidases into the bioactive lipid product 12(S)-HETE.

12(S)-HETE Activation of its Cognate Receptor, 12HETER-1 and Functional Outcomes

12(S)-HETE binding its G protein-coupled receptor (GPCR), 12HETER-1 (previously known as GPR31) (Guo et al. 2011b) regulates a plethora of biological functions through activation of p42/44 MAPK (Szekeres et al. 2000), PI3K/AKT (Szekeres et al. 2002), and IP3/DAG/PKC α (Liu et al. 1995) pathways (Figure 4). 12HETER-1 was an orphan GPCR cloned from PC-3 prostate cancer cells and identified as a high affinity 12(S)-HETE receptor by radioligand binding assays (Guo et al. 2011b). 12-LOX signaling was shown to activate NF- κ B, which leads to the induction of proliferation and resistance to apoptosis (Kandouz et al. 2003). In normal tissues, 12-LOX signaling has been shown to regulate vasoconstriction, catecholamine synthesis, inflammation, and immune cell recruitment (Lacape et al. 1992; Phillis et al. 2006). The lipid enzyme also plays a role in various pathological conditions such as hypertension, atherosclerosis, Parkinson's, diabetes, and Alzheimer's (Tucker & Honn 2013).

In cancer cells 12-LOX activation of the above signaling pathways leads to a variety of cancer phenotypes such as angiogenesis (Nie et al. 2006), motility (Honn et al. 1994a; Timár et al. 1993), invasion (Chen et al. 1994; Guo et al. 2011b), proliferation (Ottino et al. 2003), induction of MMP-9 expression/extracellular matrix degradation (Dilly et al. 2013), cell spreading (Honn et al. 1989), secretion of cathepsins B and L (Honn et al. 1994c; Ulbricht et al. 1996) non-destructive endothelial cell retraction with tumor cell adhesion (Tang et al. 1993), and survival (Guo et al. 2011a; Pidgeon et al. 2003). For example, 12(S)-HETE activation of PKC α in a low metastatic rat prostate cell line led to motility and cell invasion (Liu et al. 1994a), and melanoma cell motility was enhanced with 12(S)-HETE stimulation (Timár et al. 1993). In agreement with the observation that 12(S)-HETE can stimulate cell motility, 12(S)-HETE treatment induced cytoskeletal rearrangements and endothelial cell retraction in a time and concentration dependent

manner, an effect that was also dependent on PKC (Tang et al. 1993). It was later discovered that PKC activation by 12(S)-HETE led to the secretion of cathepsin B, a proteinase well known for its role in invasion (Honn et al. 1994c). As another example of 12(S)-HETE pro-tumorigenic functions, endogenously produced 12(S)-HETE in tumor cells was found to enhance tumor cell adhesion *in vitro* and lung colonization *in vivo*, an effect mediated by α IIb β 3 integrin, a commonly expressed integrin on tumor cells (Chen et al. 1994; Liu et al. 1994b). The bioactive lipid was also shown to stimulate the surface expression of α v β 3 integrin resulting in a more spread cell morphology, thereby preventing apoptosis in endothelial cells (Pidgeon et al. 2003; Tang et al. 1995). Prostate cancer cells engineered to overexpress 12-LOX formed larger, more vascularized tumors compared to empty vector control cells when injected subcutaneously into mice (Nie et al. 1998). It was later discovered that these cells secrete high levels of VEGF, a growth factor well known for its role in angiogenesis (Nie et al. 2006). Interestingly, 12-LOX activity increases VEGF production at the mRNA level and was found to be dependent on PI3K/AKT signaling. Under hypoxic conditions 12-LOX induces HIF1 α transcription, protein production, and increases its DNA binding ability (Krishnamoorthy et al. 2010). Given that a major target of HIF1 α in hypoxia induced angiogenesis is VEGF, the importance of 12-LOX in the regulation of angiogenesis is quite clear.

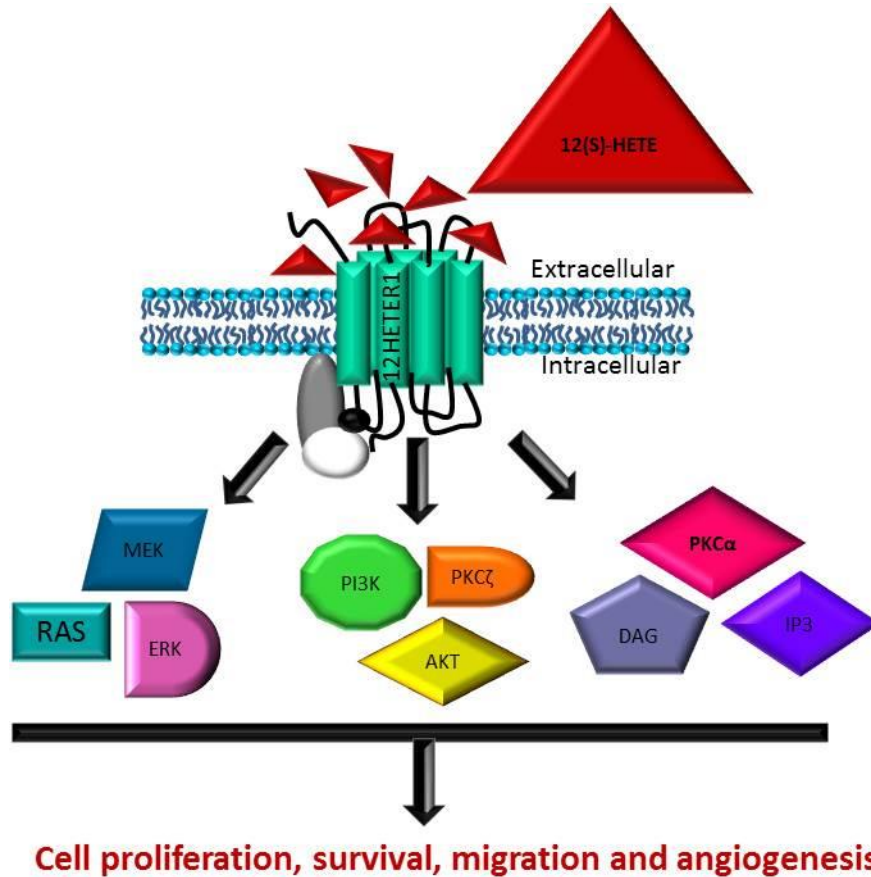

Figure 4. Activation of 12HETER-1 by 12(S)-HETE. After its production by 12-LOX, 12(S)-HETE diffuses from the cell and work in an autocrine fashion through 12HETER-1 (GPR31). This activates the signaling cascades of MAPK, PI3K/AKT, and IP3/DAG/PKC α to promote cell proliferation, survival, migration, and angiogenesis.

12-LOX Expression in Normal vs. Tumor Tissue

Under normal circumstances, 12-LOX is expressed in platelets (Izumi et al. 1990), megakaryocytes, umbilical vein cells, and endothelial cells (Funk 1996; Funk et al. 1990; Hansbrough et al. 1990; Nakadate et al. 1986). However, its expression can be induced by pro-inflammatory stimuli in cancer cells (Funk et al. 1990; Nakadate et al. 1986; Yamamoto 1992; Yoshimoto 1982). Sequencing and real time PCR data have confirmed that A431 epidermal carcinoma cells and prostate cancer cell lines express specifically the platelet type 12-LOX (Gao et al. 1995; Haggmann et al. 1996). Both 12-LOX and its bioactive lipid product, 12(S)-HETE, are associated with prostate (Gao et al. 1995; Guo et al. 2011b; Nie et al. 1998; Tang & Honn 1994), pancreatic (Ding et al. 1999), ovarian (Guo et al. 2011a), breast (Connolly & Rose 1998; Natarajan et al. 1997), skin (Tang et al. 2000; Timár et al. 1999), lung (Chen et al. 1994), and colon cancer (Wong et al. 2001b). For example, elevated 12-LOX mRNA was positively correlated with advanced stage/high grade human prostate cancer in 38% of cases (Gao et al. 1995).

12-LOX Structure and Enzymatic Activation

The 12-LOX enzyme, a 75kDa structure, consists of a single polypeptide chain folded into two important domains, the N-terminal β -barrel or PLAT domain (Polycystin-1, Lipoxygenase, Alpha-Toxin), and catalytic C-terminal portion containing octahedrally bound non-heme iron and the substrate binding site (Brash 1999; Ivanov et al. 2011). 12-LOX is a cytosolic enzyme that can be recruited to the membrane and subsequently activated under various physiological conditions (Haggmann et al. 1996). For instance, the levels of glutathione peroxidases available to reduce 12(S)-HPETE to 12(S)-HETE affect 12-LOX activity (Jung et al. 1997; Suzuki et al. 2000). Additionally, 12-LOX activity or protein levels can be altered by thrombin or Ca^{2+} (Baba et al. 1989; Haggmann et al. 1993), tumor promoting phorbol ester (12-O-tetradecanoylphorbol-13-

acetate, TPA) (Hagmann et al. 1993), glucose or angiotensin II (Natarajan et al. 1993), γ -radiation (Onoda et al. 1994), and EGF stimulation (Chang et al. 1993; Hagmann et al. 1996; Liu et al. 1997; Natarajan et al. 1997).

Integrin β 4 Regulation of 12-Lipoxygenase

A novel paradigm of 12-LOX activation was suggested when yeast two hybrid screening using a cDNA library generated from A431 cells, an epidermoid carcinoma cell line, revealed 12-LOX interacts with integrin β 4 (β 4) (Tang et al. 2000). Other 12-LOX interacting partners were identified as lamin A, keratin, and the phosphoprotein C8FW (Tang et al. 2000). The pro-tumorigenic functions of 12-LOX compounded with the role β 4 plays in cancer cell motility (discussed in the following section) led us to hypothesize that 12-LOX interaction with β 4 may influence cellular adhesion through disruption of hemidesmosomes, cell survival/apoptosis, and the invasive growth of carcinoma (Figure 5).

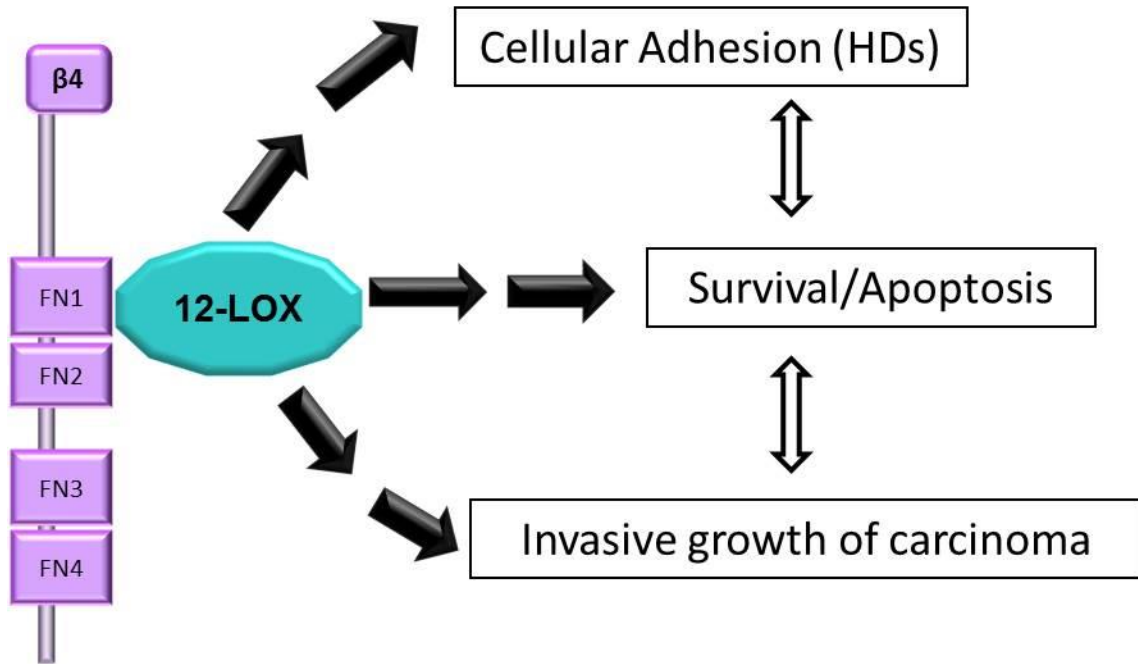

Figure 5. Hypothetical Implications of 12-LOX Interaction with $\beta 4$. 12-LOX and $\beta 4$ association is hypothesized to affect cell adhesion through disruption of hemidesmosomes, cell survival or apoptosis, and cancer cell invasive growth.

The remaining information in this section was adapted from the following submitted publication to the International Journal of Cancer, unless otherwise indicated. The data figures excerpted highlight my contribution to the manuscript.

“Convergence of Eicosanoid and Integrin Biology: 12-LOX seeks a partner”

Keqin Tang^{*}, Daotai Nie^{*}, Yinlong Cai[‡], Sangeeta Joshi[‡], Elizabeth Tovar[‡], Stephanie C. Tucker[‡], Krishna Rao Maddipati[‡], John D. Crissman[‡], and Kenneth V. Honn[‡]

^{*}Department of Radiation Oncology and [‡]Pathology, Wayne State University School of Medicine, Karmanos Cancer Institute, Detroit, MI 48202; [§]Department of Internal Medicine, University of Michigan, Ann Arbor, MI 48109

To begin addressing the above hypothesis, we sought to determine the impact of integrin stimulation on 12-LOX localization and activity. Initial biochemical studies from our lab found that $\beta 4$ activation, either by the activating antibody 3E1 or $\beta 4$'s natural ligand laminin, which both bind the extracellular head of $\beta 4$, led to the recruitment of 12-LOX to the integrin as seen by co-immunoprecipitation of $\beta 4$ and 12-LOX in A431 cells, A431 12-LOX overexpressing cells, and CHO cells. Both 3E1 and laminin are well established activators of $\beta 4$ (Mainiero et al. 1995). The interaction was time dependent, first appearing 5 minutes post $\beta 4$ activation and tapering off after 60 minutes. 12-LOX and $\beta 4$ were both transfected into CHO cells, which do not endogenously express either protein. In this cell line we found 12-LOX to interact specifically with the cytoplasmic tail of $\beta 4$ based on the use of various $\beta 4$ truncation mutants. Using confocal microscopy, we confirmed that $\beta 4$ activation resulted in 12-LOX translocation from the cytosol to the membrane where it interacted with $\beta 4$ in A431 cells. Addition of integrin $\beta 1$ antibody did not

result in 12-LOX translocation or lead to its association with the integrin, which strongly suggested that the interaction of 12-LOX and $\beta 4$ was specific.

Next, we demonstrated that recruitment of 12-LOX to $\beta 4$ on integrin stimulation of A431 cells led to an increase in 12-LOX enzymatic activity reflected by the production of 12(S)-HETE in a time dependent manner as measured by RP-HPLC and LC-MS (Figure 6). Cells were stimulated with 3E1 for the indicated times and then treated with AA for 15 minutes. Without the addition of AA in non-stimulated cells, there was a low basal level of 12(S)-HETE production. With AA treatment, again in the absence of stimulation, there was a further increase in 12(S)-HETE levels because the cells were given the substrate for 12-LOX to produce 12(S)-HETE, and again represents basal level 12-LOX activity. With 3E1 stimulation, there was a further time dependent increase in 12(S)-HETE levels.

Additionally, $\beta 4$ activation by 3E1 prevented BMD122-induced apoptosis. BMD122 (BHPP-benzyl-N-hydroxy-5-phenylpentanamide; BMD122-Biomide Compound 122) is a 12-LOX specific inhibitor, that exerts its function by chelating the non-heme iron within 12-LOX, which overrides the pro-survival function of 12-LOX and leads to cell death. We also showed that 12-LOX modulates $\beta 4$ -dependent cell migration in a Boyden chamber assay both on laminin or Matrigel. Specifically, A431 cells were pre-treated with 3E1 or laminin followed by EGF stimulation. Pre-treatment of the cells with either $\beta 4$ activator led to increased cell migration, compared to EGF alone, and the effect was abrogated by BMD122 inhibition of 12-LOX.

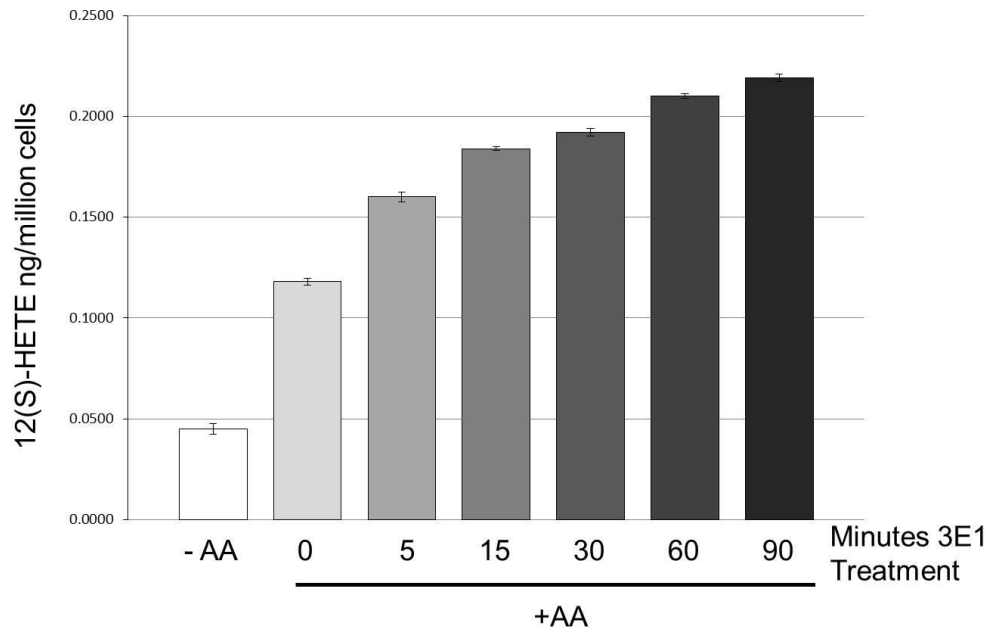

Figure 6. LC-MS Analysis of 12(S)-HETE Production Following β 4 Stimulation. A431 cells were treated with 3E1 for the indicated times, washed with HBSS, incubated with AA for 15 minutes, and then both cells and media were collected. Lipids were extracted as per standard protocols (see Materials and Methods). The data were analyzed by LC-MS in triplicate and error bars represent SEM.

To confirm that $\beta 4$ integrin ligation stimulates 12-LOX production of 12(S)-HETE, and also to confirm the role of 12-LOX in $\alpha 6\beta 4$ -mediated, EGF-stimulated migration, we transfected A431 cells with six different shRNA constructs, each targeted to a unique region of the 12-LOX gene product (Table 1). Stable transfectants were selected for with puromycin. The resulting transfectants were screened for effective 12-LOX knockdown (12-LOX KD). Both 12-LOX gene expression and protein production were assayed to validate the knockdown. Compared to the parental and non-silencing (ns) shRNA control transfected cells, the #1 and #2 12-LOX KD clones effectively decreased 12-LOX mRNA expression, as measured by RT-PCR (Figure 7A). At the protein level, clone #1 showed almost a complete knockdown of 12-LOX compared to the parental and ns shRNA control cells (Figure 7B). These two clones were used in subsequent experiments.

Construct	Mature Antisense Sequence	12-LOX Target
#1 V2LHS_112083	GATGATCTATCTCCAAATA	ORF
#2 V2LHS_112086	TGGTTTAGCACAGCTTTGG	ORF
#3 V2LHS_112087	AGAAATGTCAGTCCTAAAG	3'UTR
#5 V3LHS_335849	AGTCTTCTAGGCAGTTCCA	ORF
#6 V3LHS_335846	TGATTTCCATGGTGTAGCG	ORF

Table 1. Sequences of shRNA Constructs Targeting 12-LOX. Shown are the 12-LOX shRNA pGIPZ lentiviral mature antisense sequences and where they target the 12-LOX gene product. The #8 non-silencing shRNA control (not shown) is titled RHS_4346 with a mature antisense sequence of ATCTCGCTTGGGCGAGAGTAAG.

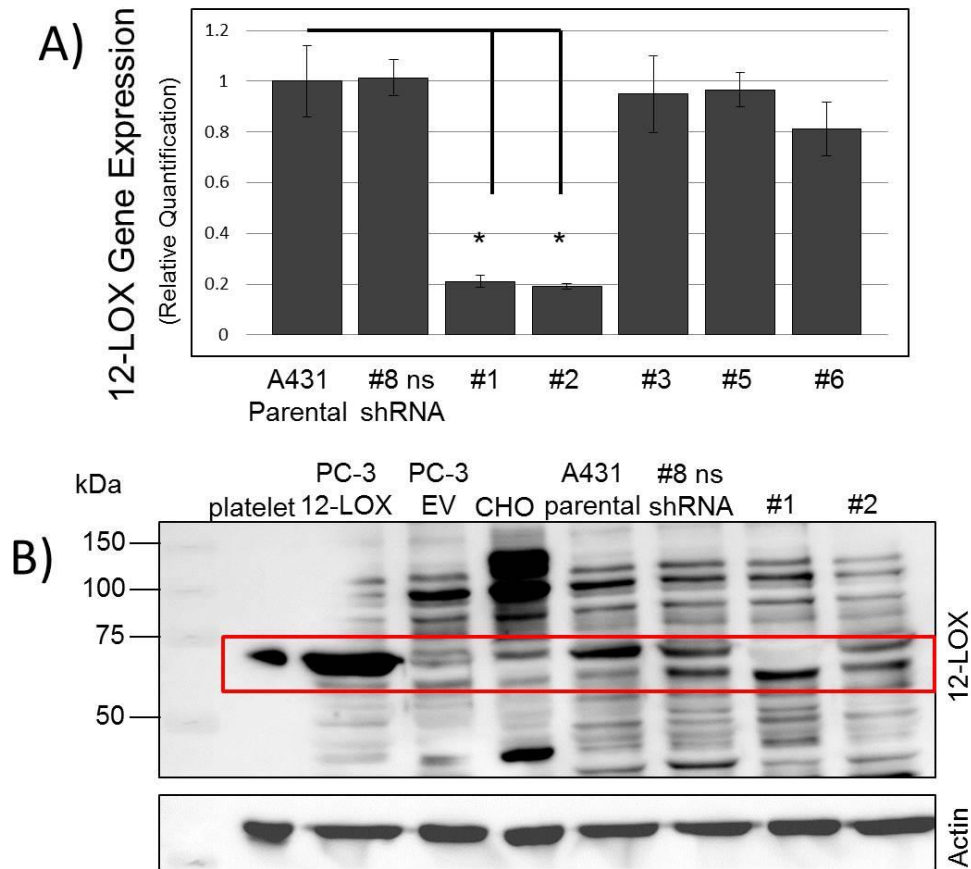

Figure 7. Validation of 12-LOX Knockdown. A) 12-LOX mRNA levels measured by RT-PCR in A431 parental, ns (non-silencing) shRNA control cells, and 12-LOX KD (knockdown) cell lines. * $p < 0.001$. B) Western blot analysis of 12-LOX protein levels in 12-LOX KD clones, ns shRNA control, parental A431, CHO (negative control for 12-LOX expression; Santa Cruz polyclonal platelet-type 12-LOX antibody appears to be recognizing another 12-LOX isoform in CHO cells as they *do not* express platelet type 12-LOX), prostate cancer PC-3 12-LOX overexpressors (positive control for 12-LOX), PC-3 empty vector control cells, and platelet whole cell lysate (positive control for 12-LOX expression).

We then analyzed for 12(S)-HETE production on 3E1 stimulation in the 12-LOX KD cells, which we already confirmed activates 12-LOX enzymatic activity in wild type cells (Figure 8A). Previously characterized PC-3 prostate cancer cells stably expressing 12-LOX were used as a positive control for 12(S)-HETE production (Nie et al. 2006). Cells were stimulated with 3E1 in the presence of AA, the substrate for 12-LOX, to produce 12(S)-HETE. In both the parental and ns shRNA control cells, 3E1 stimulation resulted in a marked increase of 12(S)-HETE production compared to AA treatment alone. This response was not seen in the #1 or #2 12-LOX KD clones, indicating that 12-LOX interaction with activated β 4 stimulates its enzymatic activity. Production of 12(S)-HETE in response to β 4-activated 12-LOX recruitment leads to autocrine activation of the cognate 12(S)-HETE receptor, 12HETER-1, which in turn activates MAPK signaling (Guo et al. 2011b; Pidgeon et al. 2007). As seen in Figure 8B, parental and ns shRNA control cells respond to 3E1 with an increase in ERK phosphorylation. The #1 clone had higher levels of basal ERK activation, but no increase in response to 3E1. In addition to confirming the effectiveness of 12-LOX KD by shRNA #1, these results strongly support a role for β 4 and 12-LOX acting together.

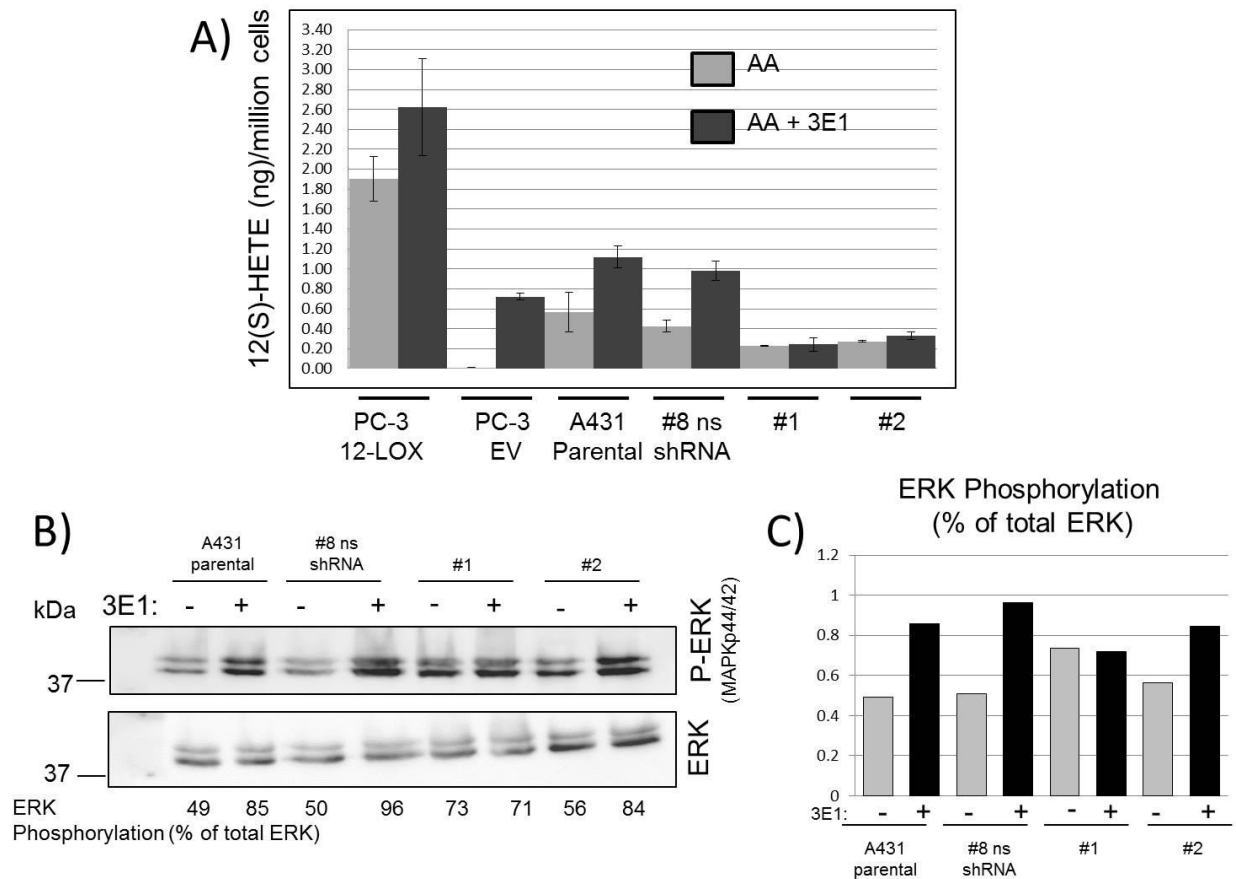

Figure 8. 12-LOX Knockdown Inhibits β 4-mediated 12(S)-HETE Production and Downstream ERK Activation. A) No increase in 12(S)-HETE levels were seen with 3E1 stimulation in #1 and #2 12-LOX KD clones. 12-LOX activity was measured by 12(S)-HETE production using LC-MS after a six hour incubation with 3E1 and AA. Lipids were extracted as per standard protocols (see Materials and Methods). The data were analyzed in triplicate and error bars represent SEM. B) #1 12-LOX KD cells do not respond to 3E1 stimulation with an increase in phosphorylated ERK levels. Western blot evaluation of phosphorylated ERK with 30 minutes 3E1 stimulation. Densitometry analysis represents the ratio of phosphorylated ERK to total ERK. C) Densitometry of part B represented in graphical form as the percentage of ERK phosphorylation normalized to total ERK.

Next, we utilized the 12-LOX KD cells to confirm the role of 12-LOX in $\alpha6\beta4$ -mediated, EGF-stimulated cell invasion (Figure 9). Consistent with previous results, 3E1 treatment increased invasion of the parental and ns shRNA control cells toward EGF, while BMD122 dramatically reduced invasion. Interestingly, invasion of the ns shRNA cells was increased in all conditions compared to the parental control and could be due to non-specific effects from the scrambled shRNA. In the #1 and #2 12-LOX KD cell lines, EGF stimulation lead to a marginal increase in invasion. This supports a role for 12-LOX in EGF-stimulated invasion. Similar to the results seen in the parental and ns shRNA cells, BMD122 significantly reduced #2 12-LOX KD cell invasion, whereas the 12-LOX inhibitor had much less of an effect on the #1 12-LOX KD cells, and is likely because most of 12-LOX is knocked down in this cell line. The ineffectiveness of EGF to stimulate increased invasion following 3E1 treatment in the #1 12-LOX KD cells confirms our hypothesis that 12-LOX is involved in $\alpha6\beta4$ -mediated, EGF stimulated invasion. Additionally, because the #1 12-LOX KD cells did not respond to BMD122 with a decrease in cell invasion, we are confident that 12-LOX is indeed knocked down, further validating our results.

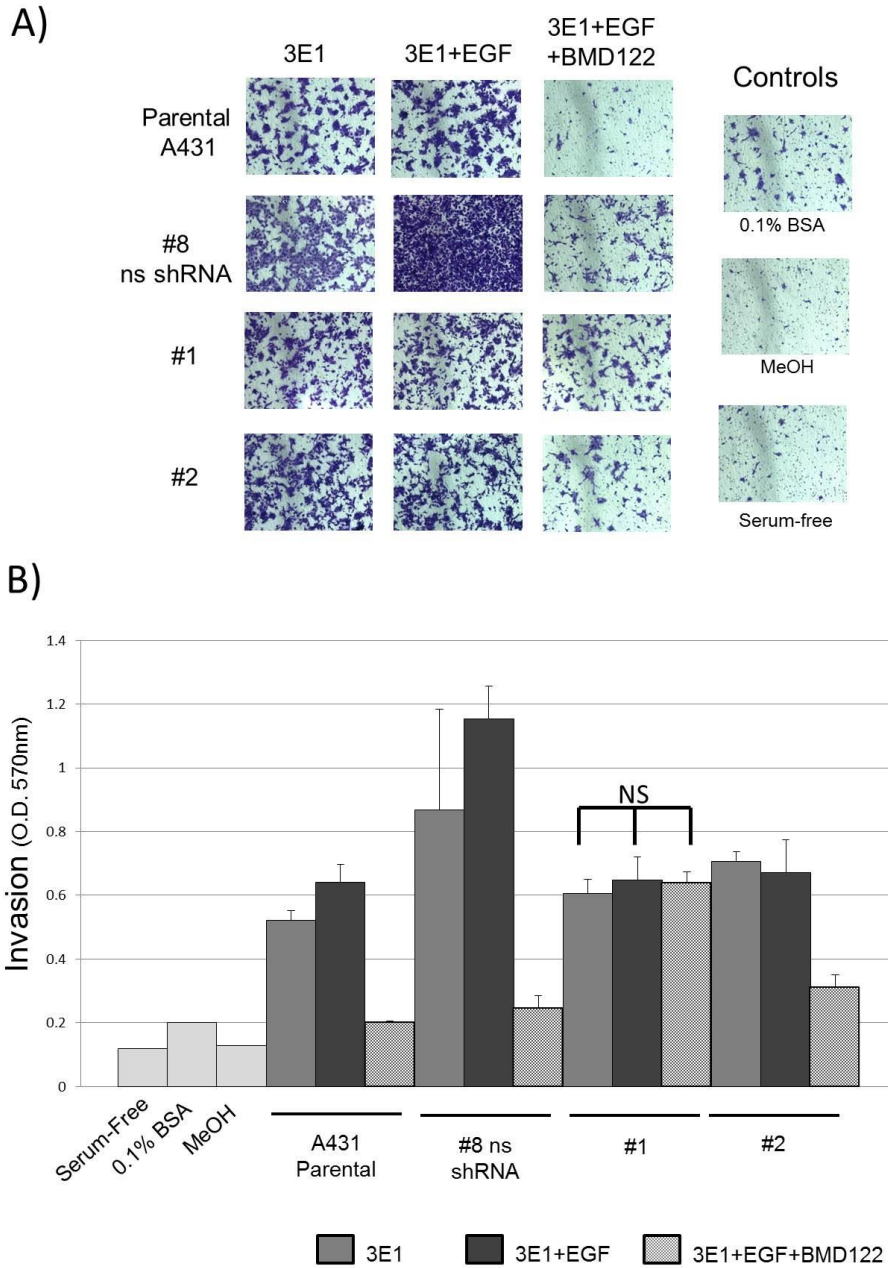

Figure 9. 12-LOX Knockdown Renders Cells Resistant to BMD122-inhibited Invasion and Non-responsive to EGF-stimulated Invasion. A) #1 12-LOX KD cell invasion minimally affected by BMD122 enzymatic inhibition of 12-LOX. Cells were pre-treated with 20 μ M BMD122, then stimulated with 3E1 or 2 ng/mL EGF and allowed to invade through a Boyden Chamber insert coated with Matrigel for 24 hours. Migration of cells toward serum free media was a negative control and 0.1% BSA served as a positive control. MeOH was the vehicle control for BMD122. Images taken at 10x. B) Invaded cells were stained with crystal violet, the dye content dissolved in 10% acetic acid, and the absorbance measured at OD_{570nm}. Columns represent the invasion reported as the mean of three samples +/- SEM.

Continued work on 12-LOX and β 4 interaction identified several important mechanisms of 12-LOX regulation. β 4 activation by either 3E1 or laminin was found to result in SRC-dependent phosphorylation of 12-LOX at residues Y19 and Y614 in A431 cells (Dilly *et al.* manuscript pending). The subsequent activation of 12-LOX resulted in 12(S)-HETE production. Additionally, 3E1 and laminin stimulation led to phosphorylation of tyrosine residue 1494 on the tail of β 4 (Figure 10). The importance of this residue will be discussed in later chapters. Sequential mutagenesis studies of the β 4 cytoplasmic tail revealed that 12-LOX interacts specifically with an eleven amino acid segment of β 4, named FNO1-2 (residues 1137-1147 of β 4), embedded in FNO1 of the first FNIII (fibronectin three) repeat of the β 4 cytoplasmic tail (Figure 10) (Joshi *et al.* manuscript pending). Transfection of FNO1-2 into CHO or A431 cells competed with full-length β 4 for interaction with 12-LOX as assessed by co-immunoprecipitation (Joshi *et al.* manuscript pending) Ectopic expression of GR16, a macrodomain of the β 4 tail that contains the FNO1-2 segment, was able to compete with full length β 4 for interaction with 12-LOX in A431 cells. This led to reduced cell migration, a decrease in 12-LOX activity as measured by 12(S)-HETE production with LC-MS, decreased proliferation, and decreased colony formation with no effect on cell adhesion (Joshi *et al.* manuscript pending). Subcutaneous injection of A431 cells stably expressing GR16 resulted in suppressed tumor growth in athymic nude mice compared to parental cells, suggesting that β 4 interaction with 12-LOX has significant bearing on tumor progression (Joshi *et al.* manuscript pending). Gene expression analysis of tumor tissue from the GR16 mice showed a decrease in VEGF, HIF1 α , and BCL-2 levels while BAX levels were increased. This suggests that without β 4 and 12-LOX interaction, tumor angiogenesis was suppressed while apoptosis was upregulated, which further confirms the role of 12-LOX in cell survival and tumor progression. These studies are the first indication of integrin regulation of a lipid enzyme in tumor

progression, and represent a major advancement in our knowledge of the link between cell adhesion and eicosanoid upregulation.

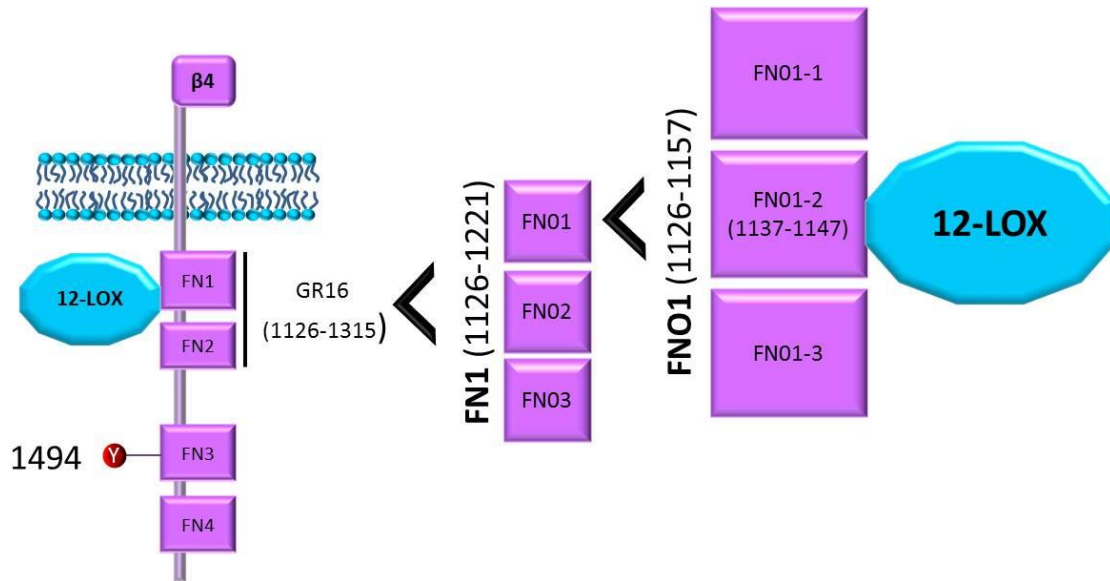

Figure 10. Schematic of 12-LOX Interaction with $\beta 4$. $\beta 4$ integrin consists of an extracellular domain, a transmembrane region, and a long and unique cytoplasmic tail containing two pairs of fibronectin three repeats (FNIII; [FN1+ FN2] and [FN3 +FN4]) separated by a connecting segment. By sequentially mutating segments of the $\beta 4$ cytoplasmic tail, we found that 12-LOX interacts within the GR16 (1126-1315) region of $\beta 4$. This segment is comprised of the FN1 and FN2 repeats. GR16 was then divided into three subdomains, and one of those domains, named FN1, was divided further into three more subdomains: FNO1, FNO2, and FNO3. Further analysis showed 12-LOX interacts within FNO1, a 23 amino acid segment (residues 1126-1157). Microdomain mapping localized the minimum 12-LOX binding site to an 11 amino acid portion of the $\beta 4$ cytoplasmic tail in FNO1, named FNO1-2 (1137-1147). Y1494 is in the FN3 region of the $\beta 4$ cytoplasmic tail.

Integrin β 4 Function in Hemidesmosomes and Cell Motility

Integrins

Integrins function in cell to extracellular matrix (ECM), and cell to cell adhesion to regulate differentiation, growth, survival, proliferation, and embryonic development through the translation of extracellular positional clues to the cytoskeleton (Dowling et al. 1996). Integrin β 4 is a member of the integrin type 1, single pass, heterodimeric glycoprotein membrane receptors, although it bears little homology to any other member due to its cytoplasmic tail (Hogervorst et al. 1990). There are 18α and 8β integrins subunits that can combine to form 24 distinct heterodimeric integrin receptors. β 4 exclusively partners with α 6 integrin (Hynes 2002) to form the foundation for hemidesmosomes, which are specialized structures that function to adhere epithelial cells to the basement membrane through interactions with laminins, and allow cells to maintain proliferative potential (Borradori & Sonnenberg 1999).

β 4 Structure and Function in Normal Tissues

β 4 is expressed normally in epithelial (Kajiji et al. 1989; Sonnenberg et al. 1990), Schwann (Einheber et al. 1993), endothelial (Kennel et al. 1992), and double negative T-cells (Ramarli et al. 1998). The integrin has a cytoplasmic tail over 1,000 amino acids long and contains two pairs of FNIII repeats (FN1 + FN2; FN3 + FN4) separated by a 142 amino acid connecting segment (Figure 11) (Hogervorst et al. 1990). This unique cytoplasmic tail allows β 4 to interact with hemidesmosomal structural proteins as well as signaling molecules and adapters. β 4 heterodimerizes with α 6 to interact directly with the basal lamina, where its preferred binding partner is laminin-5 (renamed laminin-332) (Hao et al. 1996; Hynes 2002; Rousselle et al. 1991; Spinardi et al. 1995). Additional components of the hemidesmosome are the bullous pemphigoid antigens 180 (BPAG2) and 230 (BPAG1), plectin/HD1, and the membrane tetraspanin CD151.

BPAG2 is a transmembrane protein belonging to the plakin family and interacts with laminin in the ECM and the FN3 repeat of β 4 (Koster et al. 2003). Plectin and BPAG1 are directly connected to the intermediate keratin filaments in the cell. Plectin binds two different sites of the β 4 tail; the first site spans the FN2 repeat and the first 35 amino acids of the connecting segment (Niessen et al. 1997), the second site spans the c-terminal tail after the FN4 repeat (Geerts et al. 1999). The N-terminus of BPAG1 interacts with the c-terminal portion of β 4 (Koster et al. 2003). The tetraspanin family is known for regulating cell adhesion to the ECM, yet CD151 function in hemidesmosomes is still unclear. Immunohistochemistry of CD151 null mice revealed that although these mice have normal hemidesmosomes, β 4 staining was abnormal and disorganized during wound healing (Cowin et al. 2006), indicating the tetraspanin may be important for proper β 4 localization.

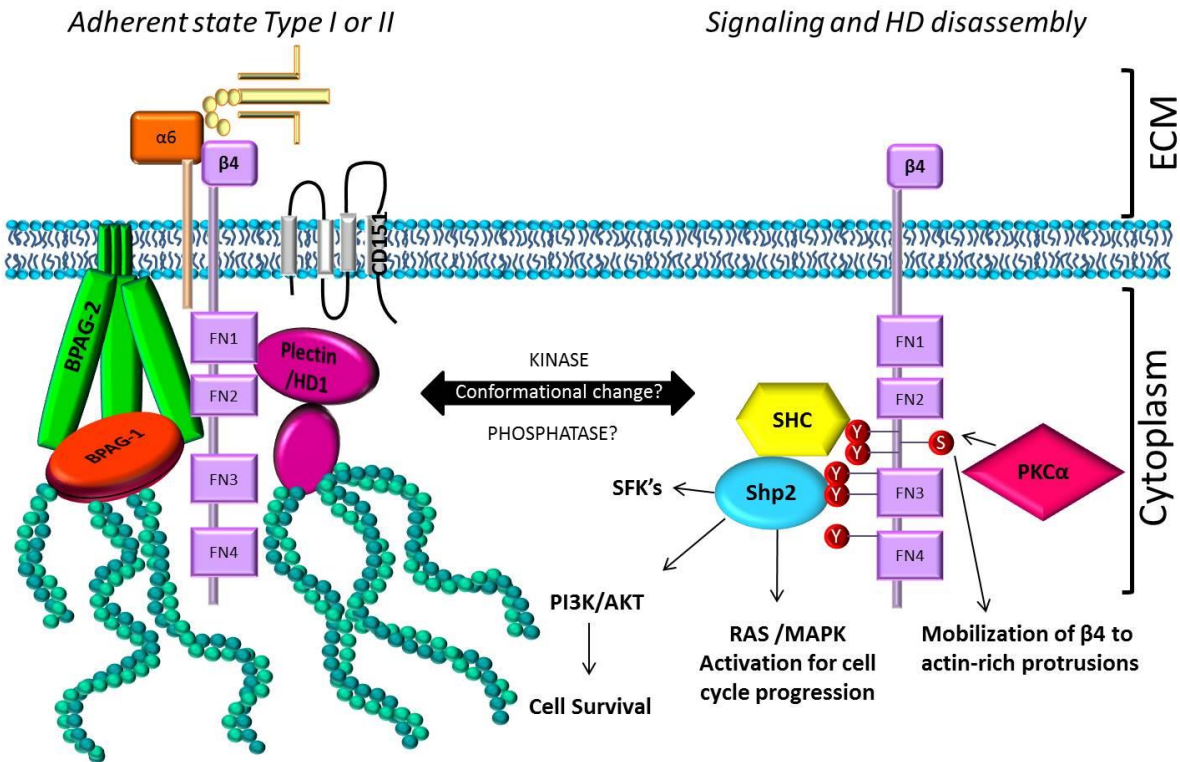

Figure 11. $\beta 4$ Plays a Role in Hemidesmosomes in Stably Adherent Cells While Assisting in Cell Signaling and Migration Following Activation. In stably adherent cells $\beta 4$ is incorporated into hemidesmosomes and interacts with $\alpha 6$, laminin, plectin, BPAG1, BPAG2, and CD151 in a type I hemidesmosome. $\beta 4$ interaction with only plectin is classified as a type II hemidesmosome. $\beta 4$ integrin consists of an extracellular portion, a transmembrane region, and a long and unique cytoplasmic tail containing two sets of fibronectin three repeats (FNIII; [FN1+ FN2] and [FN3 +FN4]) separated by a connecting segment. $\beta 4$ interacts with laminin and $\alpha 6$ extracellularly while interacting with plectin, BPAG1, and BPAG2 intracellularly through its FNIII repeats. Plectin and BPAG-1 interact with intermediate filaments. After $\beta 4$ activation, SRC family kinases, SHC, and SHP2 are recruited to activate PI3K/AKT for cell survival and RAS/MAPK for activation of cell cycle progression. The mechanism of $\beta 4$ activation has not been fully elucidated. In both normal keratinocytes and in cancer cells, growth factor activation results in $\beta 4$ phosphorylation involving PKC α and its translocation from hemidesmosomes to actin rich lamellipodia protrusions where it actively participates in migration.

Fully formed, type I hemidesmosomes are comprised of all the above proteins, and are found in stratified and pseudostratified epithelial tissues (Niessen et al. 1996; Sonnenberg et al. 1991). Type II hemidesmosomes are found in the constantly migrating simple gut epithelial cells and are characterized by $\beta 4$ interaction with plectin (Uematsu et al. 1994). Type II hemidesmosomes are thought to be the precursor to type I because they are much more dynamic in nature, are compatible with migration, and contain the two primary proteins necessary for hemidesmosome seeding. Interestingly, the cytoplasmic tail of $\beta 4$, independent of its extracellular domain interaction with ligand, is necessary and sufficient for incorporation of the integrin into hemidesmosomes, meaning it does not have to heterodimerize with $\alpha 6$ to interact with plectin (Nievers et al. 1998).

Genetic ablation of $\beta 4$ in mice identified the primary function of the integrin, and we now know that hemidesmosomes protect epithelial tissues from mechanical loads and sheer stress (Jones et al. 1994). The $\beta 4$ knockout mice presented with a complete absence of hemidesmosomes which led to marked separation of the dermal and epidermal tissues, extensive skin denuding, gastrointestinal issues, respiratory failure, and death within hours of birth (Dowling et al. 1996). $\beta 4$ mutations in humans lead to a disease called epidermolysis bullosa. The severity of the condition depends on the type and extent of the mutation(s), but is not usually as severe as that seen in the $\beta 4$ knockout mice.

Not only does $\beta 4$ form the backbone for hemidesmosomes in cellular adhesion, it is also a signaling competent receptor even though it harbors no intrinsic kinase ability. When $\beta 4$ is activated (by binding either laminin or 3E1), the integrin undergoes phosphorylation by a SRC family kinase, SHC is recruited, and RAS and PI3K signaling cascades are activated (Dans et al. 2001; Gagnoux-Palacios et al. 2003; Mainiero et al. 1997; Mainiero et al. 1995; Shaw et al. 1997). $\beta 4$ signaling results in cell cycle progression and proliferation through activation of RAS/MAPK

(Mainiero et al. 1997; Mainiero et al. 1995; Shaw et al. 1997). $\beta 4$ also promotes cell survival through activation of PI3K/AKT (Schwartz 1997; Tang et al. 1999). However, in cells expressing wild-type p53, $\beta 4$ activation of AKT can lead to apoptosis (Bachelder et al. 1999b).

In normal keratinocytes, EGF stimulation leads to hemidesmosome disassembly through PKC α activation, subsequent $\beta 4$ phosphorylation, and mobilization of $\beta 4$ to F-actin rich protrusions at the leading edge of the cell in migration (Gipson et al. 1993; Mainiero et al. 1996; Rabinovitz et al. 1999; Wilhelmsen et al. 2007). This clearly indicates that $\beta 4$ plays a role in migration, which stands in stark contrast to its role in cellular adhesion. The consequences of $\beta 4$ phosphorylation in terms of functional or phenotypic outcomes is complex, cell type, and tissue type specific and will be elaborated further on in this dissertation.

$\beta 4$ Expression in Cancer

The association between $\beta 4$ and cancer has been established. In fact, $\beta 4$ was first identified as a tumor-associated antigen (Falcioni et al. 1988). Soon after, abnormal $\beta 4$ expression was found in epithelial tissue associated with psoriasis, a skin disorder marked by inflammation and hyper proliferation (Pellegrini et al. 1992). Since its discovery, $\beta 4$ has been associated with increased aggressiveness of multiple cancers, including those outlined below. It is overexpressed in metastatic squamous cell carcinomas and associated with accelerated recurrence (Kimmel 1986; Savoia et al. 1993), synthesized *de novo* in invasive thyroid cancer (Rabinovitz & Mercurio 1996), and the degree of $\beta 4$ expression in colon cancer was found to correlate with invasion (Falcioni et al. 1994). At the onset of early-stage pancreatic adenocarcinoma, $\beta 4$ expression is increased and its localization redistributed from the basal side of pancreatic duct cells to the plasma membrane and cytoplasm (Cruz-Monserrate et al. 2007). $\beta 4$ is also expressed in more aggressive melanomas (Raymond et al. 2007), and highly expressed in osteosarcoma cell lines and patient samples (Wan

et al. 2009). Further evidence of $\beta 4$ association with cancer aggressiveness was identified by the cancer outlier profile analysis (COPA) of Oncomine data, which found $\beta 4$ overexpression in a subset of aggressive prostate cancer tumors in 11 of 16 datasets (Yoshioka et al. 2013).

$\beta 4$ Function and Signaling Hijacked in Cancer: Switch from a Mechano-Adhesive Device to a Signaling Adapter for Growth Factor Receptors

Cancer cells likely retain the expression of $\beta 4$ to promote invasion and metastasis, though this may seem counterproductive because $\beta 4$ is a necessary component of hemidesmosomes, anchoring structures that are incompatible with migration. It is the subcellular localization of $\beta 4$ that is altered from a polarized basal proximity to diffuse in the cellular membrane of most cancer cells (Carico et al. 1993; Hall et al. 1991; Mariani Costantini et al. 1990). As hemidesmosomes are disassembled in cancer progression, $\beta 4$ adhesive contacts with the ECM laminins are dissolved and the integrin redistributes from its basal location becoming pericellular in the membrane. This altered localization of $\beta 4$ may very well be the cause behind the dangerous matrix-independent $\beta 4$ signaling that occurs during tumor progression because it can then interact with various growth factor receptors (GFRs), enzymes, and kinases it wouldn't normally have access to, enabling spurious activation. It is important to note that $\beta 4$ can signal independent of dimerization with $\alpha 6$, and in many cases without external stimulation by laminin (Gambaletta et al. 2000). Additionally, because it is common for tumor suppressors like p53 to be lost or mutated in cancer cells, $\beta 4$ activation in a matrix-independent manner would no longer trigger apoptosis or anoikis (Bachelder et al. 1999b).

Numerous studies have shown that $\beta 4$ activation or expression in cancer cells facilitates their ability to migrate, invade, and protects them from apoptosis. Ectopic expression of $\beta 4$ was shown to be sufficient to induce cellular transformation in rodent fibroblast NIH3T3 cells and mouse embryonic fibroblasts (MEFs) (Bertotti et al. 2006). However, $\beta 4$ overexpression in the

normal human mammary epithelium cell lines MCF-10A and B5-589 did not induce cellular transformation, indicating that rodent fibroblasts are easier to transform (Bertotti et al. 2006). $\beta 4$ has also been shown to sustain anchorage-independent growth by activating NF- κ B (Zahir et al. 2003). Colorectal cancer cell invasion through Matrigel was found to be enhanced by $\beta 4$ expression (Chao et al. 1996). B16-F10 melanoma cell lung metastasis *in vivo* are mediated by $\beta 4$ interaction with the human calcium-activated chloride channel protein (hCLCA1) in pulmonary arteries, arterioles, and interlobular venules (Abdel-Ghany et al. 2002). Under stress conditions such as serum-starvation, ectopic expression of $\beta 4$ prevented apoptosis and promoted survival by activating the PI3K/AKT pathway in breast cancer cells with mutated or dominant-negative p53 (Bachelder et al. 1999a; Bachelder et al. 1999b). A431 cells, which do not have functional p53, subjected to stress by plating on non-coated polystyrene bacterial plates undergo apoptosis by 24 hours, but antibody stimulation of $\beta 4$ rescued the cells through activation of the PI3K pathway (Tang et al. 1999). There are many more examples of $\beta 4$ promotion of tumorigenic phenotypes reviewed elsewhere (Guo & Giancotti 2004), which for the sake of brevity will not be discussed further here.

The ability of $\beta 4$ to influence the important cellular functions described above may arise from fact that $\beta 4$ interacts with a plethora of signaling entities such as enzymes, adapter proteins, membrane receptors, and transcription factors, which allows $\beta 4$ to coordinate signals to many different pathways under various physiological conditions (e.g. adherent or non-adherent states). In fact, $\beta 4$ has been shown to act as a signaling adapter for GFRs, such as EGFR, ErbB2, c-Met, Ron, and the insulin-like growth factor-1 receptor, to promote cancer cell invasion (Bertotti et al. 2005; Falcioni et al. 1997; Fujita et al. 2012; Gambaletta et al. 2000; Guo et al. 2006; Hintermann

et al. 2001; O'Connor et al. 1998; Santoro et al. 2003; Shaw et al. 1997; Trusolino et al. 2001; Yoshioka et al. 2013).

It is the unique cytoplasmic tail of $\beta 4$ that allows for cooperative signaling with GFRs. Targeted deletion of the cytoplasmic tail of $\beta 4$ in mice results in defective neoangiogenesis induced by tumor xenografts (Nikolopoulos et al. 2004), indicating this region is required for signaling in tumorigenesis. On the other hand, the $\beta 4$ cytoplasmic tail downstream of residue 1355 (located after the connecting segment between the two pairs of FNIII repeats, see Figure 10) is dispensable for $\beta 4$ adhesive function, because mice lacking this C-terminal portion assemble fully-formed hemidesmosomes (Nikolopoulos et al. 2004). In parallel, the extracellular domain of $\beta 4$ is not necessary to promote invasion, seen in ErbB2-driven invasion of NIH3T3 cells where the extracellular head of $\beta 4$ was mutated and had no effect on invasion, whereas the portion encompassing residues 854 to 1183 of the $\beta 4$ cytoplasmic tail were found to be critical for invasion (Gambaletta et al. 2000). Therefore, the adhesive and signaling functions of $\beta 4$ can be separated and may be mutually exclusive.

The role of $\beta 4$ under normal circumstances, aside from forming hemidesmosomes, is to transduce extracellular locational information by activating the appropriate signaling pathways. Oncogenes can promote cell survival, proliferation, and invasion independent of adhesive cues in cancer, yet neoplastic cells still benefit from integrins by exploiting their signaling capacities. EGF (epidermal growth factor), MSP (macrophage stimulating factor), and HGF (hepatocyte growth factor), the ligands for EGFR, Ron, and c-Met respectively, can lead to the activation of $\beta 4$ (Rabinovitz et al. 1999; Santoro et al. 2003; Trusolino et al. 2001). As mentioned above in the context of normal keratinocytes, EGF stimulation of cancer cells also leads to partial hemidesmosome disassembly through PKC α phosphorylation of $\beta 4$ and mobilization of the

integrin to actin-rich protrusions such as lamellipodia to promote migration and invasion (Gipson et al. 1993; Mainiero et al. 1996; O'Connor et al. 1998; Wilhelmsen et al. 2007). Consistent with EGF activation of $\beta 4$, overexpression of ErbB2 and $\beta 4$ led to increased NIH3T3 cell invasion (Falcioni et al. 1997), implying that activated GFRs can cross-activate the integrin. Another group showed that $\beta 4$ cooperates with ErbB2 to promote PI3K-dependent invasion of NIH3T3-ErbB2 transformed cells (Gambaletta et al. 2000). Similar to EGF, MSP stimulation results in $\beta 4$ serine phosphorylation by PKC α , hemidesmosome disassembly, and $\beta 4$ translocation to lamellipodia in migrating keratinocytes (Santoro et al. 2003). In pancreatic cancer cells, immunoprecipitation and proximity ligation studies showed that after MSP treatment, Ron translocates to the cell membrane and interacts with plectin and $\beta 4$, and through activation of PI3K, disrupts $\beta 4$ /plectin interaction resulting in enhanced cell migration and colocalization of $\beta 4$ and Ron in lamellipodia (Yu et al. 2012). $\beta 4$ interaction with c-Met and activation by HGF will be discussed in the section titled “History of Integrin $\beta 4$ and c-Met Association: Interaction and Functional Significance”.

Analysis of the phosphorylation status of $\beta 4$ showed that 95% occurs on serine residues with EGF treatment (Rabinovitz 2004), and 50% of that phosphorylation occurs on S1356, S1360, and S1364, although tyrosine phosphorylation of $\beta 4$ following EGF treatment has been observed (Mainiero et al. 1996; Mariotti et al. 2001; Rabinovitz et al. 1999), and HGF is known to lead to $\beta 4$ tyrosine phosphorylation (Trusolino et al. 2001). Immunofluorescent staining of formalin-fixed paraffin-embedded or frozen tissue samples of invasive squamous cell carcinomas showed increased serine phosphorylation of $\beta 4$ and decreased hemidesmosomal structures compared to both normal tissue and carcinoma *in situ* (Kashyap 2011). In general, $\beta 4$ phosphorylation of any kind (tyrosine, threonine, serine) inhibits hemidesmosome formation (Mainiero et al. 1995). The hypothesis is that phosphorylation of $\beta 4$ interferes with plectin binding by modifying $\beta 4$

conformation and thus compromising the interaction (Dans et al. 2001; Litjens et al. 2006; Nievers et al. 1998). However, breakdown of hemidesmosomes after GFR activation of $\beta 4$ is only partial, and indicates that other residues or proteins may be phosphorylated for full hemidesmosome disassembly.

Integrin $\beta 4$ and 12-Lipoxygenase are required for HGF-Induced PC-3 Prostate Cancer Cell Invasion

As discussed previously, we found that $\beta 4$ and 12-LOX physically interact to functionally affect cell migration, apoptosis, and 12(S)-HETE production. Earlier pilot studies from our lab also evaluated whether $\beta 4$ and 12-LOX association was functionally relevant for HGF-induced invasion. It was thought that the cytoplasmic tail of $\beta 4$ could perhaps function as a signaling adapter molecule for the c-Met receptor, which is activated by HGF.

To determine the significance of $\beta 4$ and 12-LOX interaction in terms of HGF-induced invasion, PC-3 prostate cancer cells stably expressing a 12-LOX expression construct (nL12) and the neo- α controls were subjected to a Boyden chamber invasion assay (Figure 12A). Cells were seeded onto fibronectin coated inserts and stimulated with HGF. Into each cell line were also transfected different constructs of $\beta 4$: full-length (wild-type), headless (missing the extracellular head of $\beta 4$), and tailless (missing the entire cytoplasmic tail of $\beta 4$) (Figure 12B). With HGF stimulation, cells that ectopically expressed 12-LOX and either $\beta 4$ full-length or the tail of $\beta 4$, showed significantly enhanced cellular invasion compared to the non-treated controls and the neo- α controls. PC-3 cells are generally unresponsive to HGF stimulation for invasion (Humphrey et al. 1995), and this can be seen in the lack of invasion in the neo- α vector control cells when treated with HGF. These results strongly suggest that 12-LOX and the $\beta 4$ cytoplasmic tail are required for HGF-induced PC-3 cell invasion.

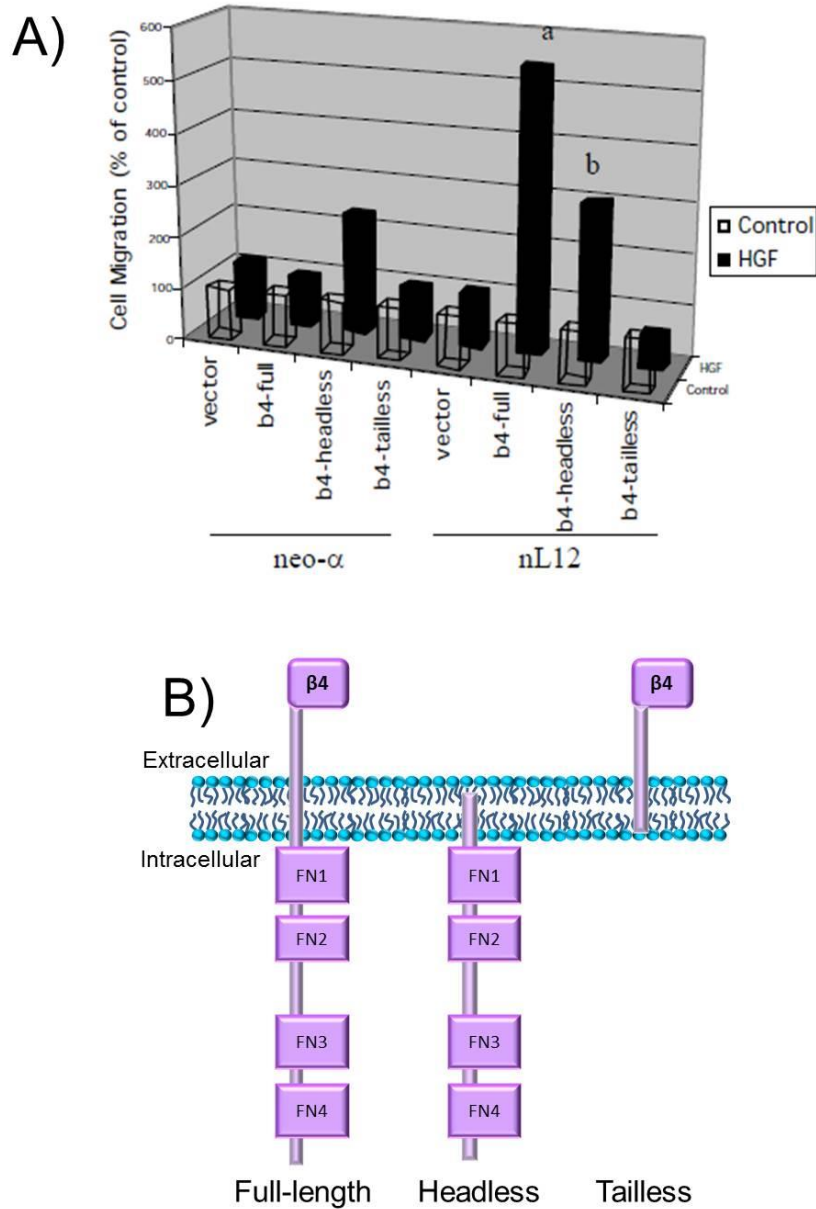

Figure 12. The Cytoplasmic Tail of $\beta 4$ and 12-LOX are Required for PC-3 Prostate Cancer Cell Invasion. A) The tail of $\beta 4$ and 12-LOX are required for PC-3 cell invasion through fibronectin in a Boyden chamber invasion assay. PC-3 cells stably expressing a 12-LOX expression construct (nL12) and the neo- α controls were transfected with the following $\beta 4$ expression constructs: B) full-length, headless, and tailless, along with a lacZ reporter construct to identify transfected cells. Cells were seeded onto fibronectin coated inserts and stimulated with 50 ng/mL HGF. a, $p < 0.0001$; b, $p < 0.005$. Part A reprinted with permission.

c-Met Receptor Tyrosine Kinase

In neoplastic tissue, analogous to c-Met function in normal tissue, c-Met signaling mediates EMT where cells detach from the ECM, and in becoming mobile, invade through the surrounding interstitial matrix by remodeling the basement membrane (Jeffers et al. 1996; Meiners et al. 1998). By enabling cellular mobility, c-Met promotes the most dangerous step of cancer progression: metastasis. The notion that $\beta 4$ and 12-LOX could facilitate this capacity is intriguing and highly relevant for combinational drug therapies, and is the basis of my own study.

c-Met Structure and Function in Normal Tissues

c-Met is a receptor tyrosine kinase (RTK) whose signaling and functioning in normal tissues is well known. The proto-oncogene was discovered in a human sarcoma cell line as a transforming Met fusion protein with the translocated promoter region (TPR-Met), later identified as an RTK, and renamed RTK-Met for its role in metastasis (Park et al. 1987; Rong et al. 1994). HGF, also known as scatter factor (HGF/SF) (Gherardi et al. 1989; Stoker et al. 1987), is the only known activator of c-Met and is secreted by stromal cells such as fibroblasts (Bottaro et al. 1991). HGF is synthesized in a pro-form and must be proteolytically cleaved to the active ligand by one of three serine proteinases, HGF activator (HGFA), matriptase, or hepsin (Owen et al. 2010). c-Met is a disulfide-linked α and β chain heterodimer processed by proteolytic cleavage of the precursor protein, much like HGF, and is expressed on epithelial or endothelial cells (Figure 13). The α -chain is extracellular while the β -chain spans the extracellular and intracellular space via a transmembrane domain. The cytoplasmic portion of the β -chain contains the tyrosine kinase and docking domains (Gherardi et al. 2003).

HGF binding to c-Met induces c-Met homodimerization, activation of its kinase domain by phosphorylation of tyrosine residues Y1230, Y1234, and Y1235, and auto-activation of the C-

terminal docking site (Y1349 and Y1356) for adapter molecules to bind to and signal from (Ponzetto et al. 1994; Weidner et al. 1996). The most common signaling adapters and transducers that directly interact with activated c-Met are signal transducer and activator of transcription 3 (STAT3), growth factor receptor-bound protein 2 (GRB2), phospholipase C- γ (PLC γ), GAB1, and SRC (Reviewed in (Gherardi 2012)). These molecules then recruit adapter proteins such as SHP2, SHC, PI3K, SOS, and others to signal to the MAPK/ERK pathway to promote cell cycle progression, PI3K/AKT for cell survival, and the GTPase RAC1 for cytoskeletal modulation and cell migration.

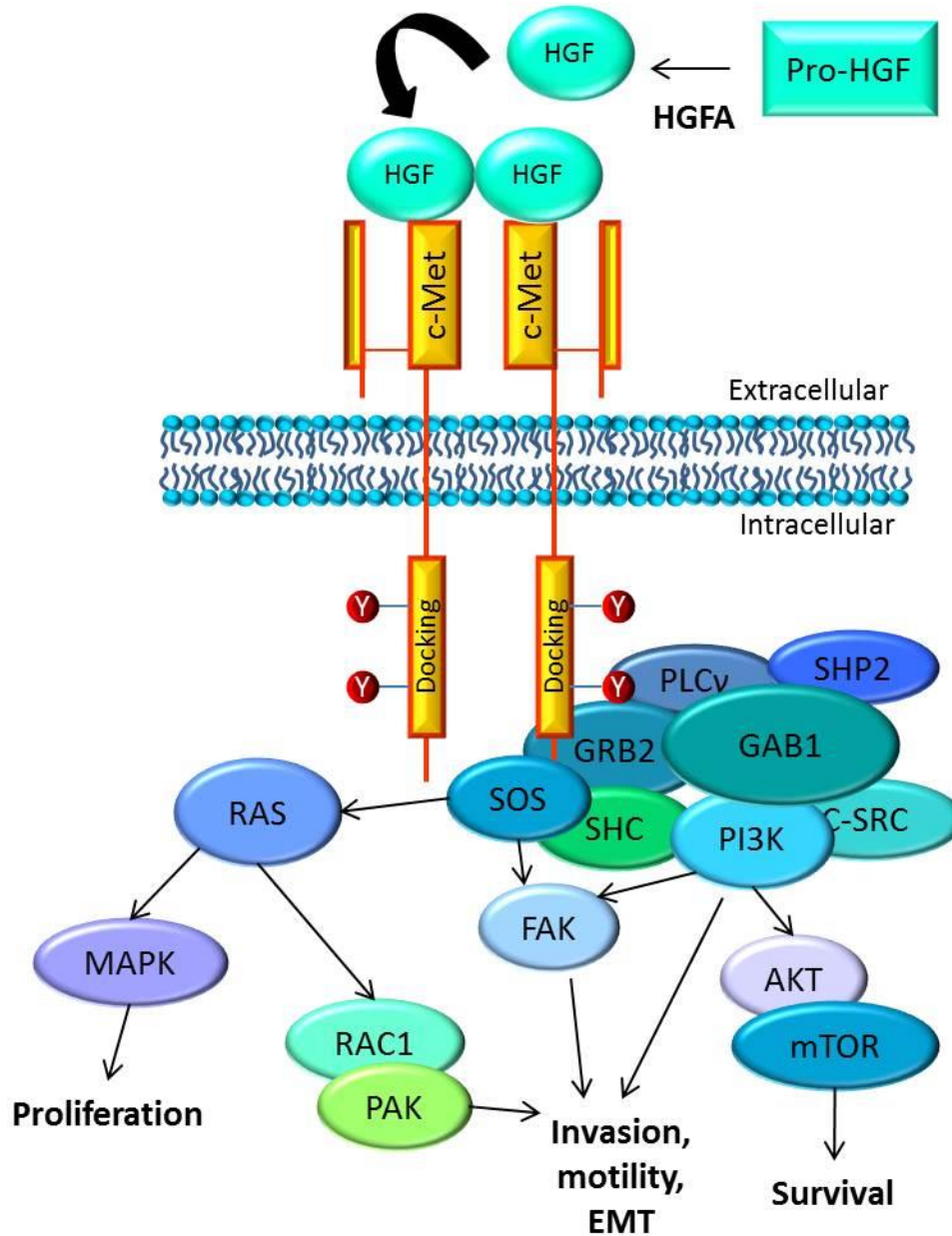

Figure 13. c-Met Signaling Axis. c-Met is a receptor tyrosine kinase composed of a disulfide linked extracellular α -chain and a membrane traversing β -chain containing the tyrosine kinase and docking domains. HGF, the ligand for c-Met, is synthesized in pro-form and must be cleaved to be activated. Following binding by HGF, c-Met homodimerizes, and the kinase domains are activated, which leads to auto-activation of the docking domains. This results in the recruitment of multiple signaling adapter and transducer molecules such as GAB1, GRB2, PLC γ , SOS, SHC, SHP2, SRC, PI3K, etc. to signal to AKT for cell survival, RAC1 for cytoskeletal remodeling, and MAPK for cell cycle progression.

c-Met has been shown to regulate a plethora of signaling pathways that play diverse biological roles, especially those related to long-distance migration and EMT, which have special significance to cancer invasion and metastasis. Survival and proliferation of epithelial and myogenic precursors during migration in embryogenesis is almost exclusively regulated by c-Met (Bladt et al. 1995; Schmidt et al. 1995; Uehara et al. 1995). Epithelial cells respond to HGF activation of c-Met by 'scattering', meaning cellular colonies are disrupted and the cells undergo EMT and become invasive (reviewed in (Thiery 2002)). The activation of RAS downstream of c-Met was found to be essential for cell scattering by several groups (Hartmann et al. 1994; Potempa & Ridley 1998; Ridley et al. 1995). The RTK also regulates branching morphogenesis in tissue patterning (Montesano et al. 1991), organ regeneration/wound healing (Nakamura & Matsumoto 1992; Stoker et al. 1987), and disruption of intercellular junctions along with matrix degradation through induction of MMP-9 activity (McCawley et al. 1998; Pepper et al. 1992).

c-Met Oncogene in Cancer

Normally, HGF activation of c-Met is a tightly regulated event dependent on ligand/receptor spatial separation, receptor internalization, and receptor degradation or recycling. However, deregulation of c-Met signaling is commonly seen in cancer, is the cause of its oncogenic properties, and can occur through a variety of mechanisms including overexpression, amplification, mutation, or co-expression of HGF and c-Met resulting in autocrine activation. The oncogenic TPR-Met fusion gene, which is constitutively active, has been identified in gastric cancer and in adjacent normal tissues (Soman et al. 1991). c-Met amplification, which causes protein overexpression and constitutive activation, is found in non-small cell lung cancer (NSCLC) (Engelman et al. 2007), and in colon cancer where the amplification encourages liver metastasis (Di Renzo et al. 1995). Although rare, germline and somatic missense mutations of c-Met,

occurring mostly in the kinase domain, have been identified in papillary renal carcinoma (Schmidt et al. 1997) and sporadic hepatocellular pediatric carcinoma (Jeffers et al. 1997). Such activating mutations allow for selective expansion of squamous carcinoma cells during metastasis (Di Renzo et al. 2000). The most common cause of deregulated c-Met signaling in cancer is protein overexpression in the absence of any genetic alterations. For example, high levels of c-Met have been detected in NSCLC (Olivero et al. 1996), breast cancer (Garcia et al. 2007), ovarian cancer (Wong et al. 2001a), malignant renal cell carcinoma, and pleural mesothelioma (Jagadeeswaran et al. 2006). Lastly, c-Met and HGF are expressed together in some cases of osteosarcoma resulting in autocrine constitutive activation (Ferracini et al. 1995).

Once c-Met signaling has been deregulated, cancer cells exploit the vast functional outcomes c-Met can mediate to promote tumor progression. In head and neck cancers, activating c-Met mutations are selected for during metastasis, implicating c-Met in cancer cell invasion (Di Renzo et al. 2000). Not only does c-Met promote invasion, it is also a potent inducer of angiogenesis by inducing the expression of VEGFA (Abounader & Laterra 2005; Bussolino et al. 1992; Grant et al. 1993). To avoid cell death, cancer cells exploit the fact that c-Met can directly interact with the death receptor Fas to prevent Fas-induced apoptosis as well as directly interacting with β -catenin to promote transcription of WNT target genes, including itself, in the promotion of tumor progression (Boon et al. 2002). Of importance to cancer are the facts that c-Met can interact with the EGFR to promote proliferation and invasion of cancer cells (Puri & Salgia 2008; Shattuck et al. 2008), as well as interact with ErbB2 in tumor progression (Yoshioka et al. 2013). Therefore, the notion that c-Met could interact and cooperate with β 4 in neoplastic cells to promote tumorigenic phenotypes, and that 12-LOX may influence this cooperation, is well supported through precedent.

History of Integrin β 4 and c-Met Association: Interaction and Functional Significance

There is a long history of research that has been executed concerning β 4 and c-Met interaction in cancer, yet some of the simplest findings have been controversial and/or non-replicable. Therefore, the details of their relationship are described below.

β 4 and c-Met were shown to constitutively associate in various cancer cell lines which endogenously or exogenously express both proteins, such as A431 epidermoid carcinoma cells, MDA-MB-435 and MDA-MB-231 breast cancer cells, GTL-16 gastric carcinoma cells, and others (Bertotti et al. 2005; Bertotti et al. 2006; Trusolino et al. 2001; Yoshioka et al. 2013). β 4 cross-activation by c-Met, where c-Met was activated by HGF, constitutively activated by overexpression, or activated by mutation, resulted in enhanced SHC and SHP-2 binding to β 4, PI3K activation, increased SRC activity, and finally AKT and ERK activation (Bertotti et al. 2006; Trusolino et al. 2001). This activation of β 4 by c-Met was shown to increase anchorage-independent growth and enhanced invasion of cells endogenously expressing both proteins, as well as in transfected cells, through phosphorylation of the β 4 cytoplasmic tail (Bertotti et al. 2006; Trusolino et al. 2001). HGF dramatically increased the invasion of MDA-MB-435 breast cancer cells transfected with β 4, and knockdown of β 4 in A431 cells reduced HGF-induced invasion (Trusolino et al. 2001). A mouse xenograft of MDA-MB-435 cells showed 7/10 mice had multiple pulmonary metastases of β 4 transfected cells versus 3/10 mice with only one instance of metastasis in the control group (Trusolino et al. 2001). HGF stimulation resulted in β 4 clustering at adhesive contacts and lamellipodia in MDA-MB-231 cells (Trusolino et al. 2000), indicating that not only can HGF lead to β 4 activation, but that there are functional consequences. Chimeric protein studies suggest that both the intra and extracellular domains of c-Met interact with β 4 and that β 4 does not have to be liganded (i.e. stimulated) nor function as an adhesive device to enhance c-Met signaling,

as MDA-MB-435 cells expressing only the cytoplasmic tail of $\beta 4$ still respond to HGF in invasion (Trusolino et al. 2001). Additionally, $\beta 4$ does not have to be heterodimerized with $\alpha 6$ to enhance c-Met signaling (Merdek et al. 2007).

Given the implications of $\beta 4$ and c-Met cooperation in cancer, controversy over whether or not the two interact spurred reports questioning role of $\beta 4$ as a signaling adapter for c-Met. Subsequently, it was found that c-Met and $\beta 4$ do not interact as measured by co-immunoprecipitation using A431, MDA-MB-435 cells transfected with $\beta 4$, and MDA-MB-231 cells with the same lysis buffer and protocol used previously (Chung et al. 2004). It is possible that the interaction is transient and therefore was missed by the investigators. Using MDA-MB-435 cells overexpressing c-Met (no endogenous $\beta 4$), the same group demonstrated that c-Met could function independently to promote invasion (Chung et al. 2004). They also showed HGF activation of $\beta 4$ did not result in increased downstream signaling through SHP-2, AKT, or ERK, and the intracellular signaling domain of $\beta 4$ alone was not sufficient to enhance c-Met mediated migration (Merdek et al. 2007), as previous reports had suggested. While ectopic expression of $\beta 4$ generally promoted invasion, Chung *et al.* found the effect was not specific to HGF-induced invasion as invasion toward other chemoattractants also increased (Chung et al. 2004).

In a contrasting study, c-Met was shown to enhance $\beta 4$ overexpression-induced transformation and anchorage-independent growth of rat fibroblasts (Bertotti et al. 2005). Further, $\beta 4$ activation by constitutively active, overexpressed c-Met was again shown and HGF stimulation lead to an increase in SRC, SHP2, GAB1, and ERK activation (Bertotti et al. 2006). Additionally, siRNA-mediated knockdown of $\beta 4$ abolished HGF-induced colony formation (Bertotti et al. 2006), supporting a role for $\beta 4$ cooperation with c-Met. When $\beta 4$ was expressed, with or without its extracellular domain, there was an increase in the size and number of MDA MB-435 colonies

formed (Bertotti et al. 2006). Inhibition of SHP2 interaction with $\beta 4$ through mutation in the same breast cancer cells led to a decrease in colony formation, and dominant-negative SRC also decreased anchorage-independent growth (Bertotti et al. 2006). Of note is the observation that in breast cancer cells, constitutively active SRC acts to upregulate HGF transcriptionally to promote cancer progression through autocrine loop activation (Wojcik et al. 2006).

The most recent report to analyze the functional relationship of c-Met with $\beta 4$ suggested that the $\beta 4$ 'signaling domain' (the cytoplasmic tail from residue 1355 onward), potentiates ErbB2 and c-Met signaling in tumor cells (Yoshioka et al. 2013). This study showed that c-Met and $\beta 4$ associate, as measured by co-immunoprecipitation, in DU145 prostate cancer cells. Furthermore, knockdown of $\beta 4$ decreased HGF-dependent cell proliferation and invasion (Yoshioka et al. 2013). However, in isolated tumor cells from $\beta 4$ -1355T mutant mice, neither HGF nor NRG treatment result in c-Met or ErbB2 activation, respectively, whereas in cells from the wild-type parental mice c-Met and ErbB2 phosphorylation was apparent after stimulation via their cognate ligands (Yoshioka et al. 2013). Instead of suggesting that $\beta 4$ enhances GFR downstream signaling as the authors claim, these data imply that the $\beta 4$ signaling domain is necessary for both c-Met and ErbB2 activation, a conclusion not supported by other experimental evidence. For example, in MDA-MB-435 cells, that do not express $\beta 4$, HGF induced c-Met phosphorylation and the cells exhibited significant invasion toward HGF (Chung et al. 2004). HGF stimulation was also shown to activate AKT and ERK downstream of c-Met in the same cell line by another group (Merdek et al. 2007). The data suggest that $\beta 4$ is not required for c-Met signaling or functioning in this background. Nonetheless, despite the variability in the data, the studies detailed above point to c-Met and $\beta 4$ crosstalk, emphasizing the importance of $\beta 4$ in cancer. Yet it still remains unclear exactly how $\beta 4$ and c-Met cooperate in cancer cells and what this means in terms of functional significance.

Hypothesis

The potential for $\beta 4$ to be a signaling adapter for c-Met in c-Met-promotion of tumor invasion/metastasis, together with our own observation that the cytoplasmic tail of $\beta 4$ along with 12-LOX were required for HGF-induced PC-3 prostate cancer cell invasion allowed us to hypothesize that $\beta 4$ uses 12-LOX as a scaffold, so as to enhance the invasive signaling originating from c-Met on binding HGF, modulating cell scattering and invasion (Figure 14).

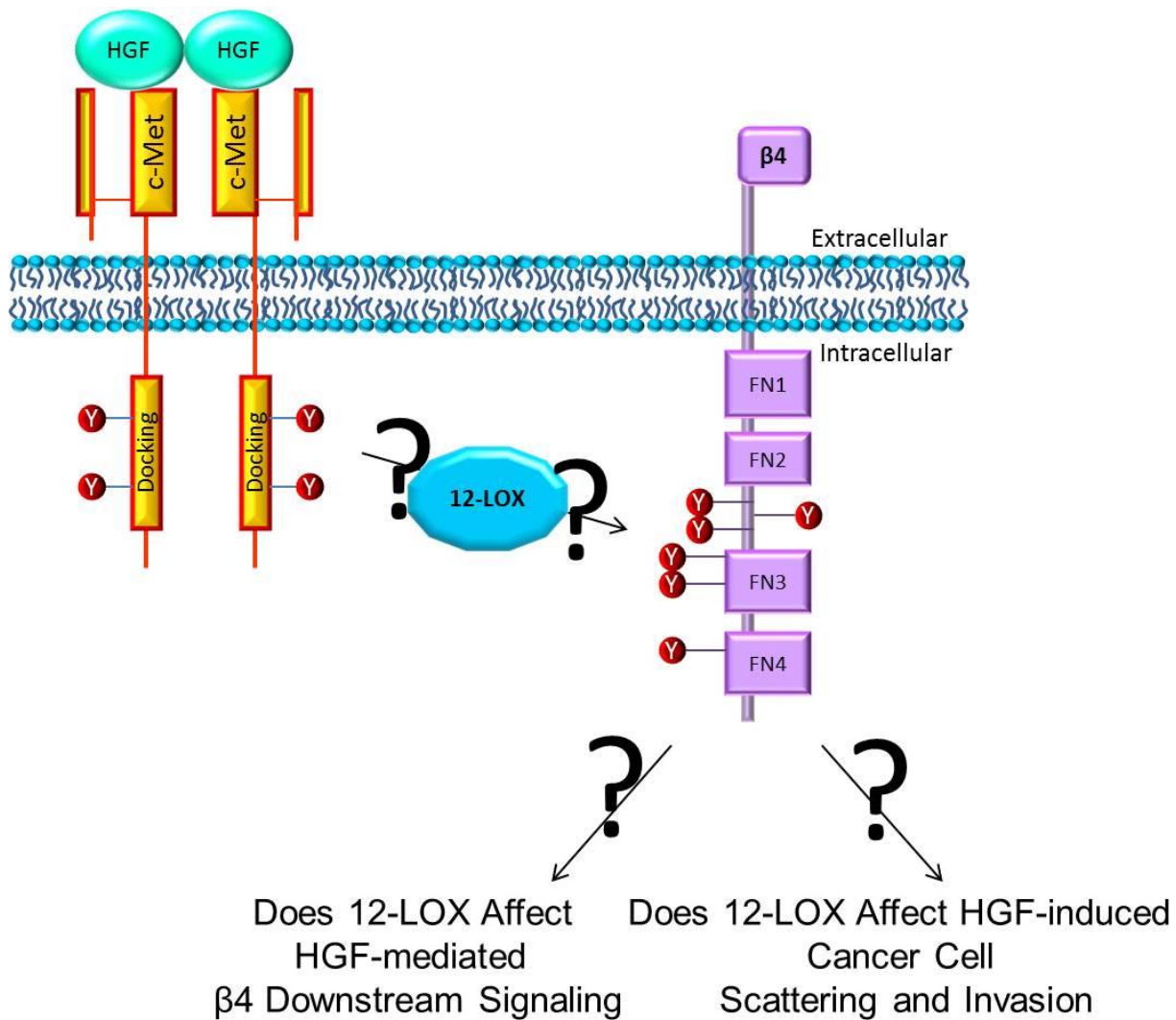

Figure 14. Hypothesis. We hypothesize that in collaboration with $\beta 4$, 12-LOX acts as a scaffold to enhance the invasive signaling originating from c-Met on binding HGF, modulating cell scattering and invasion. HGF stimulation of c-Met results in activation via phosphorylation of the receptor. Several reports suggest that c-Met can cross-activate $\beta 4$, but it is unclear whether this occurs and if so, what the mechanism is. We propose that 12-LOX is involved in $\beta 4$ activation following HGF treatment and that in association with $\beta 4$, 12-LOX acts as a scaffold to promote HGF-induced functions such as cell scattering and invasion in cancer cells.

CHAPTER 2. MATERIALS AND METHODS

Cell Culture and Treatments

A431 cells, a human epidermoid carcinoma cell line, were obtained from the ATCC and were cultured in DMEM media containing 4.5 g of glucose containing 10% fetal bovine serum, streptomycin (100 mg/ml), and penicillin (100 units/ml) (Gibco, Grand Island, NY). The human prostate cancer cell lines PC-3, PC-3M, PC-3/M derivatives, and DU145 along with CHO cells (Chinese Hamster Ovary) were cultured in RPMI 1640 media containing the same additives as above. The cells were grown at 37°C in a 5% CO₂ atmosphere. PC-3 and PC-3M cells stably expressing 12-LOX expression constructs and PC-3M cells stably expressing shRNA targeted to 12HETER-1 were previously established and characterized (Guo et al. 2011b; Tang et al. 2000). The A431 12-LOX KD cells were also previously characterized (see Chapter 1). Mycoplasma negative cultures were ensured using immunofluorescent DAPI staining and the VenorGeM Mycoplasma detection kit (Sigma-Aldrich, Saint Louis, MO).

For treatment of cells with β 4 monoclonal antibody (3E1) or HGF, 2×10^6 cells were seeded in 100 mm petri dishes and serum-starved the following day for 24 hours prior to experimental use. Cells were washed 3x with serum-free media and stimulated with 3E1 (5 μ g/mL) or HGF for 30 minutes unless otherwise noted. Stimulation of the cells with HGF ranged from 10 ng/mL to 400 ng/mL in the presence of 0.25% lipid-stripped FBS to ensure full activation of the recombinant HGF. Cells were treated with the indicated concentrations of INCB28060, BMD122, or baicalein two hours prior to HGF stimulation.

Antibodies and Reagents

3E1 mAb to human β 4 integrin was from Millipore (Temecula, CA) and was used for activation of β 4, immunoprecipitation, and immunofluorescence assays. Actin mAb was also from

Millipore. Purified mouse anti-human CD104 was from BD Pharmingen (Franklin Lakes, NJ) and used for detection of $\beta 4$ via Western blot and for immunoprecipitation where indicated. CD104 (clone 439-9B) was from eBioscience (San Diego, CA). The integrin $\beta 4$ residue-specific anti-phosphotyrosine antibody (Tyr-1494; abbreviated $\beta 4$ -1494 throughout this manuscript) was from ECM Biosciences (Versailles, KY). Antibodies to platelet-type 12-LOX (C-20), Met (C-12):sc-10, plectin (C-20), and donkey anti-goat IgG-HRP were from Santa Cruz Biotechnology (Santa Cruz, CA). Anti-mouse and anti-rabbit IgG-HRP were from GE Healthcare (Piscataway, NJ). GAPDH, VEGFR2, phospho-c-Met (Y1234/1235), and total or phosphorylated AKT (S473) and ERK (T202/Y204) antibodies were from Cell Signaling (Danvers, MA). Global phosphotyrosine antibody (PY20) was from Enzo Life Sciences (Plymouth Meeting, PA). Laminin from human placenta and EGF were from Sigma-Aldrich (St. Louis, MO). Matrigel was from BD Bioscience (Bedford, MA). Human Hepatocyte Growth Factor (HGF) was from Sigma-Aldrich (Saint Louis, MO). 12(S)-HETE was from Cayman Chemical (Ann Arbor, MI). Arachidonic acid was from NuCheck (Elysian, MN). The Alexa Fluor fluorophore conjugated antibodies GAM488, DAG594, and GAR594 were from Life Technologies (Grand Island, NY). INCB28060 (INC280) was from MedChemExpress (Princeton, NJ). Baicalein was from Enzo Life Sciences (Farmingdale, NY). BMD122 (previously known as BHPP-benzyl-N-hydroxy-5-phenylpentanamide; BMD122-Biomide Compound 122) was a generous gift from Biomide Corporation (Grosse Pointe Farms, MI).

Immunoblotting and Immunoprecipitation

For protein isolation, cells were rinsed 3x with PBS and harvested using ice-cold lysis buffer (1% Triton X-100, 150 mM NaCl, 10 mM Tris, pH 7.4, 1 mM EDTA, 1 mM EGTA, pH 8.0, 0.2 mM sodium ortho-vanadate, 0.2 mM PMSF, 0.5% NP-40) with Protease Inhibitor Cocktail and

EDTA solution added (Thermo Scientific, Rockford, IL). For phosphorylated proteins, cells were harvested using lysis buffer and then snap frozen in liquid nitrogen. Lysates were sonicated for six seconds at 30% duty cycle, and then clarified by centrifugation (10,000 x g; 10 minutes). Protein concentration was determined using BCA Protein Assay Reagent (Thermo Scientific, Rockford, IL). 50 ug of protein in 4x SDS-PAGE sample loading buffer was used for immunoblotting. For immunoprecipitation, lysates were normalized using protein concentration, pre-cleared with Protein G beads (Millipore, Billerica, MA) for 1 hour at 4°C, and incubated with the indicated antibody or species matched IgG for control overnight at 4°C with end-over-end rotating. The next day, Protein G beads were incubated with the lysates for two hours at 4°C again with end-over-end rotating. The immunoprecipitates or whole cell lysates were then boiled for five minutes in SDS sample buffer, separated on either an 8% or 10% SDS-polyacrylamide gel, transferred to a nitrocellulose membrane, and immunoblotted using primary and the respective secondary HRP-conjugated antibodies. Visualization of detected bands was done with ECL reagent (Thermo Scientific, Rockford, IL) using the FluorChem imaging system and software from Alpha Innotech (San Leandro, CA). Densitometric data was obtained using FluorChem software.

Cell Transfection

Knockdown of gene expression by shRNA was performed using Lentiviral pGIPZ constructs containing shRNA targeted to unique regions of the 12-LOX gene, that were purchased from Open Biosystems (Rockford, IL) and were designated as follows: V2LHS_112083 (#1), V2LHS_112086 (#2), V2LHS_112087 (#3), V3LHS_335849 (#5), V3LHS_335846 (#6), RHS4346 (#8). For stable transfections, A431 cells were transfected with 2 µg plasmid DNA, using Lipofectamine LTX transfection reagent from Invitrogen (Grand Island, NY). 48 hours later, cell media was switched to DMEM containing 1 ug/mL puromycin (Invitrogen, Grand Island, NY).

Cells were selected for three weeks until all non-transfected cells were dead. *Treatment of cells with Scrambled, FNO1, and FNO1-2 peptides (synthesized by Invitrogen, Grand Island, NY):* At 60% confluence, cells were serum-starved 24 hours and then transfected using Chariot (Active Motif, Carlsbad, CA) with peptides (500 ng) for 4-6 hours in serum-free media. Transfection of β -galactosidase served as a positive control and as a reporter of transfection efficiency. Images of β -galactosidase staining were taken at 400x. Cells were utilized immediately following Chariot transfection.

Measurement of 12-Lipoxygenase Activity LC-MS

Enzymatic activity of 12-LOX was determined by measuring 12(S)-HETE production using liquid chromatography-mass spectrometry. Cells (8×10^5) were seeded into six well plates and serum-starved overnight the following day using serum-free phenol red-free media. Prior to experimental use, cells were stimulated with 3E1 or HGF in the presence of 10 μ m arachidonic acid in 1% fatty acid-free BSA. AA untreated cells served as controls. As an additional control, wells without cells were treated with arachidonic acid to account for the spontaneous oxidation of arachidonic acid into 12(S)-HETE (experimental 12(S)-HETE production values are adjusted based on this number). The detailed lipid extraction protocol and analysis procedures have been described (Maddipati & Zhou 2011). Briefly, after 6 or 24 hours, conditioned media from the cells were collected into Eppendorf tubes and 5 μ L 15-HETE-d8 was added as an internal standard to monitor extraction efficiency. Supernatants containing cell lipids were subjected to solid phase extraction using Strata X 33u Polymeric Reversed Phase columns (30 mg/1mL; Phenomenex, Torrance, CA), followed by elution of lipids from extracts with methanol. These were evaporated under a stream of nitrogen and reconstituted in 50 μ L LC-MS grade methanol. Immediately before LC-MS analysis, 50 μ L of 35 mM ammonium acetate was added. Data were repeated in triplicate

and samples were analyzed by the Lipidomics Core at Wayne State University. For the time course measurement of 12(S)-HETE production in parental A431 cells stimulated with 3E1, cells were incubated with 3E1 for the indicated 90, 60, 30, 15, 5, or 0 minutes, washed 1x with serum-free phenol red-free media, then treated with 10 μ M arachidonic acid (in 1% fatty acid free BSA) for 15 minutes. Controls were the same as above. Cells and media were then collected into Eppendorf tubes and 15-HETE-d8 was added as an internal standard. Lipids were extracted and samples analyzed as biological triplicate by the Lipidomics Core at Wayne State University.

Confocal Immunofluorescence

Cells were grown to 80% confluency on glass coverslips coated with 250 μ g/mL Matrigel and serum starved overnight prior to the indicated treatments. Cells were washed 3x with PBS and fixed with 3.7% formaldehyde in PBS for five minutes at 37°C followed by fixation with ice-cold methanol in the freezer for three minutes. For rehydration and permeabilization, cells were incubated in antibody dilution buffer (TBS, 0.1% Triton X-100, and 2% BSA) for ten minutes. This and subsequent labeling steps were done in humidified chambers at room temperature. Cells were incubated in primary antibody (1:100) for one hour, washed 3x with PBS, then incubated in the corresponding secondary fluorophore-conjugated antibody (1:500) for 30 minutes, and washed again 3x with PBS. In the case of double immunofluorescence, the second target protein was stained exactly as above sequentially. Lastly, cells were stained for DAPI 10 minutes, washed 3x with PBS then mounted in Mowiol. Images were taken at 63x with an oil immersion lens on a Leica TCS SP5 laser scanning confocal microscope at the Microscopy, Imaging, and Cytometry Core of Wayne State University.

Real-Time PCR

2 µg of RNA isolated using the Macherey-Nagel NucleoSpin RNAII kit (Bethlehem, PA) was reverse-transcribed (Applied Biosystem's High Capacity Reverse Transcription Kit, Foster City, CA). Real-time PCR was performed using 4.5 uL of a 1:5 dilution of the reverse transcribed cDNA along with 5 uL Taqman Gene Expression Master Mix (Applied Biosystems, Foster City, CA) and 0.5 uL of primer per reaction. ALOX12 (HS00167524) and GAPDH primers were from Applied Biosystems (Foster City, CA). All sample reactions were run in triplicate on the AB 7500 Fast Real Time PCR System. The relative expression of 12-LOX was quantified by the Ct value measured against the internal standard GAPDH using the 7500 Fast System SDS software v1.4.0 provided by Applied Biosystems (Foster City, CA).

Invasion Assay

Boyden chamber inserts with 8 µm pores (BD Falcon, Franklin Lakes, NJ) were coated with 250 µg/mL growth factor-reduced Matrigel in 100µL of phenol red-free, serum-free media. After incubation at 37°C for 1h, excess liquid was removed. Inserts were seeded with cells at a density of 5×10^5 /mL in 0.5 mL serum-free media and allowed to adhere for two hours before treatment. Where noted, cells were treated with HGF (indicated concentrations), 3E1, 2 ng/mL EGF, or 12(S)-HETE (100-600 nM). To inhibit enzymatic activity of 12-LOX, cells were pre-treated for two hours prior to treatment with 20 µM BMD122 or 10 µM baicalein. The lower chamber contained serum-free media. For controls in the lower chamber, serum-free media with 0.25% or 10% lipid-stripped FBS were used respectively. A431 and DU145 cells were allowed to invade for 18 hours and PC-3M cells for 8 hours. Transmigrant cells on the underside of the insert were fixed with methanol, stained with crystal violet, and washed twice with distilled water. Residual, non-migrated cells were gently removed. Images were taken at 10x. Membranes were

cut from the inserts, dissolved in 10% acetic acid and assayed for dye content of migrated cells at an absorbance of OD_{570nm}. Results are reported as the mean of three samples.

Adhesion Assay

96 well plates were coated with 10 µg/mL Laminin overnight at 4°C or left uncoated as a control. Wells were washed with 0.1% BSA in serum-free media, blocked with 0.5% BSA in the corresponding media for 1 hour at 37°C, then washed again. Plates were chilled on ice until cells were ready to be seeded into them. Cells were serum-starved overnight then added to the wells at a concentration of 0.5×10^4 in 0.1 mL with HGF or 3E1 treatment for 2 hours at 37°C. Non-treated cells served as a control. Where indicated, cells were treated with 20 µM BMD122 for two hours prior to seeding into plates. Wells were washed 3x and adherent cells were fixed with 4% paraformaldehyde at room temperature for 15 minutes. Visualization of cells was done using 0.1% crystal violet (20 minutes, room temperature), followed by washing 1x with water, and left to completely dry. Images of cells were taken at 10x. Adhesion was measured by dissolving crystal violet stained cells in 2% SDS and reading the absorbance at OD_{550nm}. Results are reported as the mean of three replicates.

Scatter Assay

Cells were seeded at low density (300 cells/well) into 96 well plates. At the point of colony formation (4-7 days), cells were serum-starved overnight and then treated with increasing concentrations of HGF for 16 hours. For visualization, cells were fixed with 3.7% formaldehyde in PBS for five minutes at 37°C and stained with crystal violet for 20 minutes (room temperature), followed by 3x washes with water. Images of the cells were taken at 100x. The number of intact/HGF-non-responsive colonies in each well were counted for each condition in triplicate.

Subcellular Fractionation

2×10^6 cells were seeded into 100 mm plates and serum-starved the next day. Some cells were not serum-starved ('basal' condition). Following overnight serum starvation, cells were treated with 200 ng/mL HGF for 30 minutes. Cells were then collected and fractionated with the Biovision Fractionation Kit (Milpitas, CA) per the manufacturer's instructions.

Statistical Analysis

For the experiments described above, samples were run in triplicate and statistical analysis was determined by estimating the p-value using the Student's T-test. The results are represented as the mean +/- the standard error of the mean (SEM).

CHAPTER 3. A NOVEL FUNCTION FOR 12-LIPOXYGENASE IN C-MET AND INTEGRIN β 4 AXIS CROSSTALK: INTERACTION AND FUNCTIONAL STUDIES

A431 Epidermoid Carcinoma Results

β 4 interacts with c-Met under basal conditions, but the interaction is disrupted with HGF stimulation

It was previously shown that c-Met and β 4 interact (Bertotti et al. 2005; Trusolino et al. 2001; Yoshioka et al. 2013), and that this interaction enhances c-Met signaling through the SRC-SHP2 axis leading to increased anchorage-independent growth and invasion (Bertotti et al. 2006). However, the interaction was controversial given other groups were unable to detect the above interaction or confirm the functional consequences (Chung et al. 2004; Merdek et al. 2007). Prior to addressing the hypothesis that 12-LOX may act as a scaffold to facilitate β 4-enhanced c-Met functioning, it was necessary to confirm that β 4 and c-Met interact. Co-immunoprecipitation studies were carried out in A431 cells, an epidermoid carcinoma cell line, as the association was shown to both occur and not occur in this cell line. Additionally A431 cells natively express β 4, c-Met, and 12-LOX (Figure 15A). After immunoprecipitation for β 4, c-Met associated with the integrin in serum-starved and basal (non-serum-starved) conditions (Figure 15B). On HGF stimulation, the interaction of c-Met and β 4 appeared to decrease, which was likely due to disruption of the complex during hemidesmosome disassembly as the cells are stimulated to ‘scatter’ by HGF. As a positive control, c-Met was pulled down in serum-starved cells and run next to the β 4 immunoprecipitated samples, and as a negative control, matched IgG was immunoprecipitated to detect any non-specific interactions. The blot was also re-probed for β 4 to ensure equal pull-down across samples, as was done for every immunoprecipitation following. These findings were then confirmed by performing the reciprocal immunoprecipitation, where c-Met was pulled down and the blot probed for β 4 (Figure 15C). Again, β 4 and c-Met do associate

under serum-starved conditions, but dissociate with HGF stimulation. The levels of $\beta 4$ associating with c-Met suggest both proteins exist in complexed and uncomplexed forms, as previous studies have suggested (Trusolino et al. 2001).

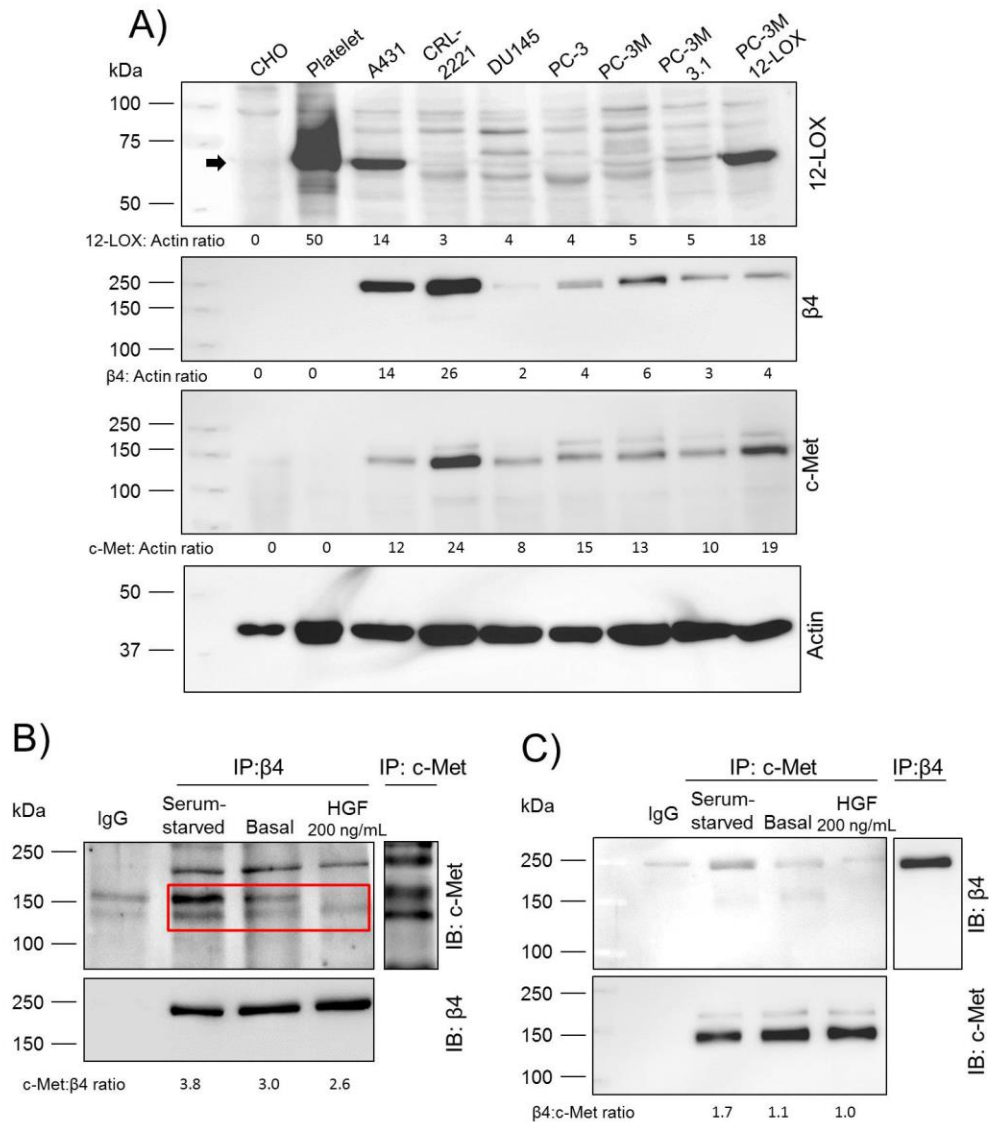
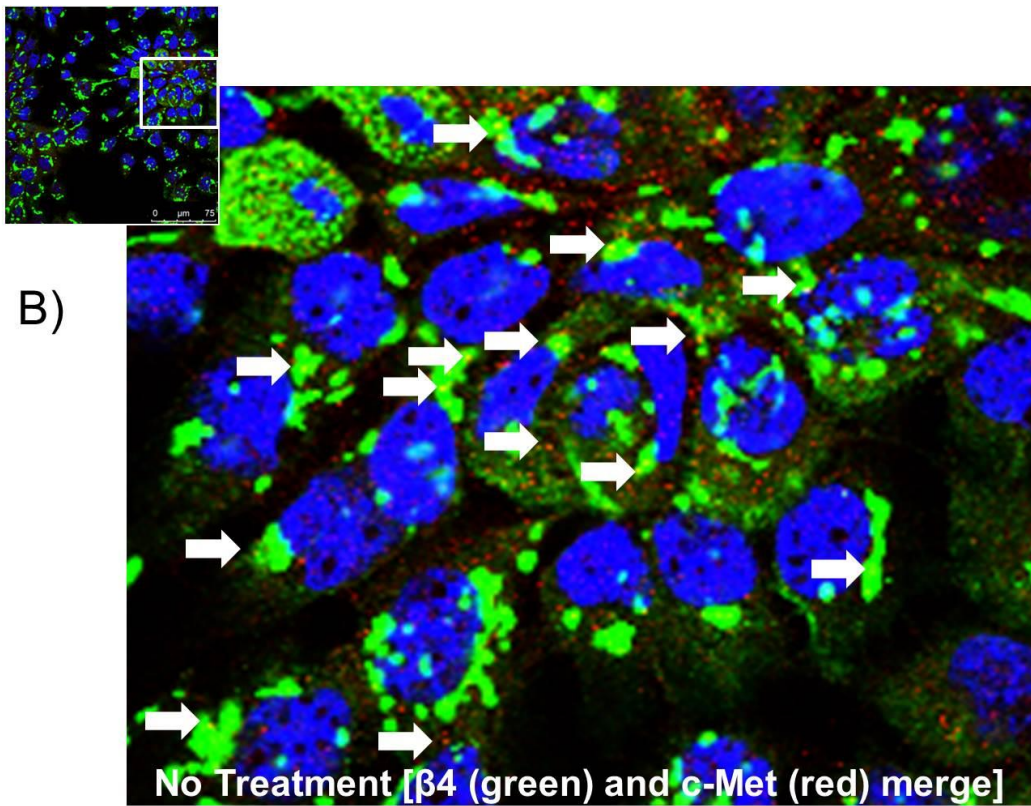
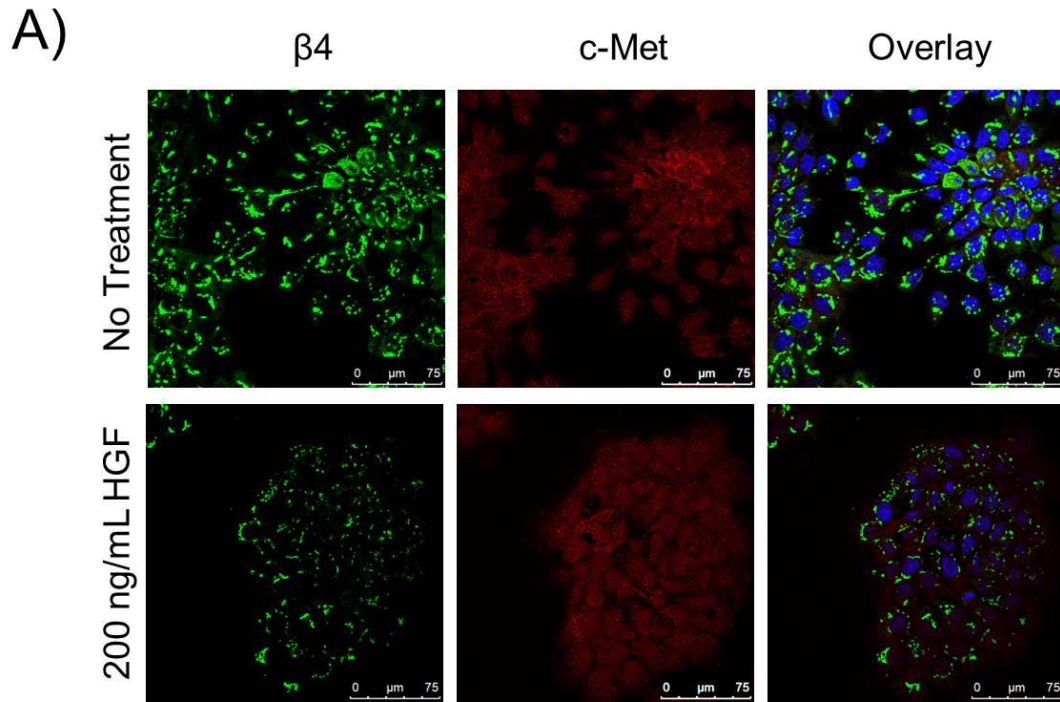
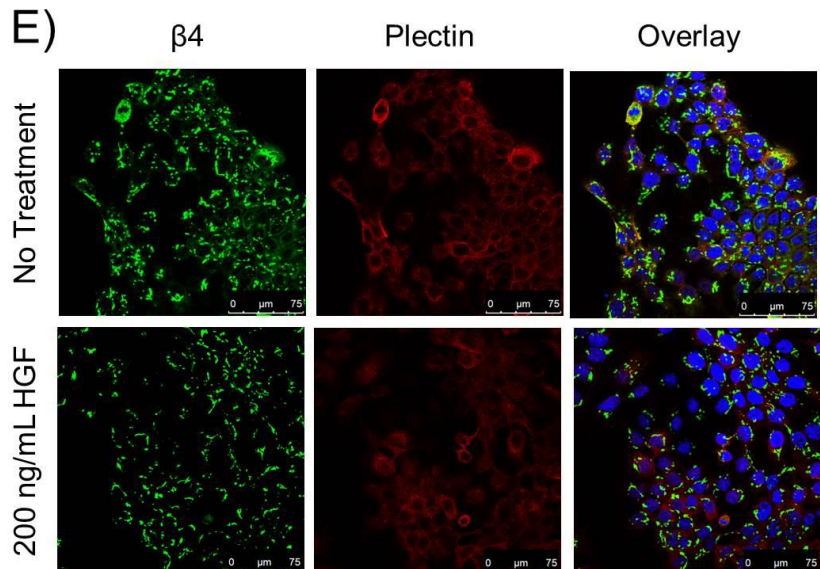
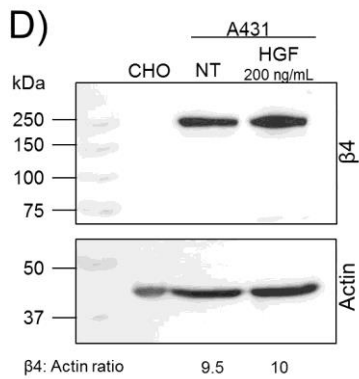
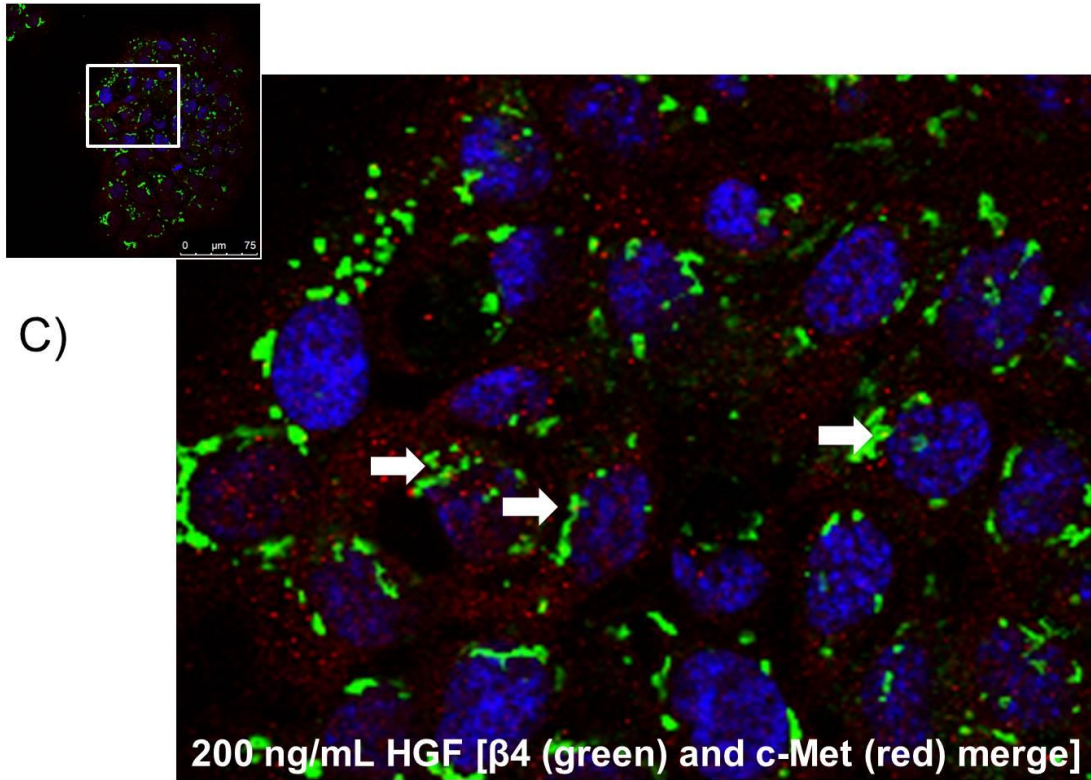

Figure 15. HGF Stimulation Disrupts the $\beta 4$ /c-Met Association A) Whole cell lysate protein levels of 12-LOX, $\beta 4$, and c-Met assayed by Western blot. CHO cells are a negative control for all three proteins, human platelets are a positive control for 12-LOX. The other cell lines included were CRL-2221 normal immortalized prostate and the following prostate cancer cell lines: DU145, PC-3, PC-3M, PC-3M 12-LOX transfectants, PC-3M empty vector controls. Densitometry represents the ratio of the protein to actin. B&C: c-Met and $\beta 4$ interact in serum-starved and non-serum-starved (basal) conditions but the interaction is disrupted with 30 minutes HGF treatment. Densitometry analysis represents the ratio of the co-immunoprecipitated protein (upper panel) to pulled-down protein (lower panel). Immunoprecipitation of matched IgG was performed as a control. Direct immunoprecipitation of the co-immunoprecipitated protein (last lane, upper panel) was performed as a positive control and exposed for a shorter duration due to band intensity. B) Immunoprecipitation of $\beta 4$ followed by Western blot analysis for c-Met. The blot was stripped and re-probed for total $\beta 4$ (lower panel). C) Reciprocal immunoprecipitation of part B.

To corroborate the co-immunoprecipitation data, immunofluorescence studies were performed to detect the c-Met and $\beta 4$ interaction. c-Met staining (red) presents as small, punctate dots in the cell membrane whereas $\beta 4$ (green) is mainly localized to intense membrane clusters (Figure 16A). Under serum-starved conditions, $\beta 4$ and c-Met co-localize mostly within the intense $\beta 4$ clusters, indicated by white arrows pointing to yellow areas of green and red overlay (Figure 16B). However, with HGF stimulation, $\beta 4$ and c-Met co-localization is almost completely lost (Figure 16C). The total levels of $\beta 4$ appear to decrease with HGF stimulation. However, immunoblot analysis showed the protein levels of $\beta 4$ remain unchanged (Figure 16D), so the integrin is likely relocating from its diffuse location within the membrane to the intense clusters with HGF stimulation. Because the immunoprecipitation data also suggest $\beta 4$ and c-Met interaction is lost with HGF treatment, we sought to determine if this was due to hemidesmosome disassembly when the cells are stimulated to scatter or become motile because of the HGF stimulus. A431 cells are known to form hemidesmosomes (Rabinovitz et al. 1999) and these structures are marked by punctate or granular staining of $\beta 4$ with a 'swiss cheese' patterning (Spinardi et al. 1995). Because the simplest hemidesmosome, type II, is marked by plectin co-localization with $\beta 4$ (Uematsu et al. 1994), we stained for both proteins. Under serum-starved conditions, $\beta 4$ (green) and plectin (red) co-localize to a greater extent than in the presence of HGF, indicating these cells are forming hemidesmosome-like structures that are disassembled with HGF treatment (Figure 16E-G).





F)

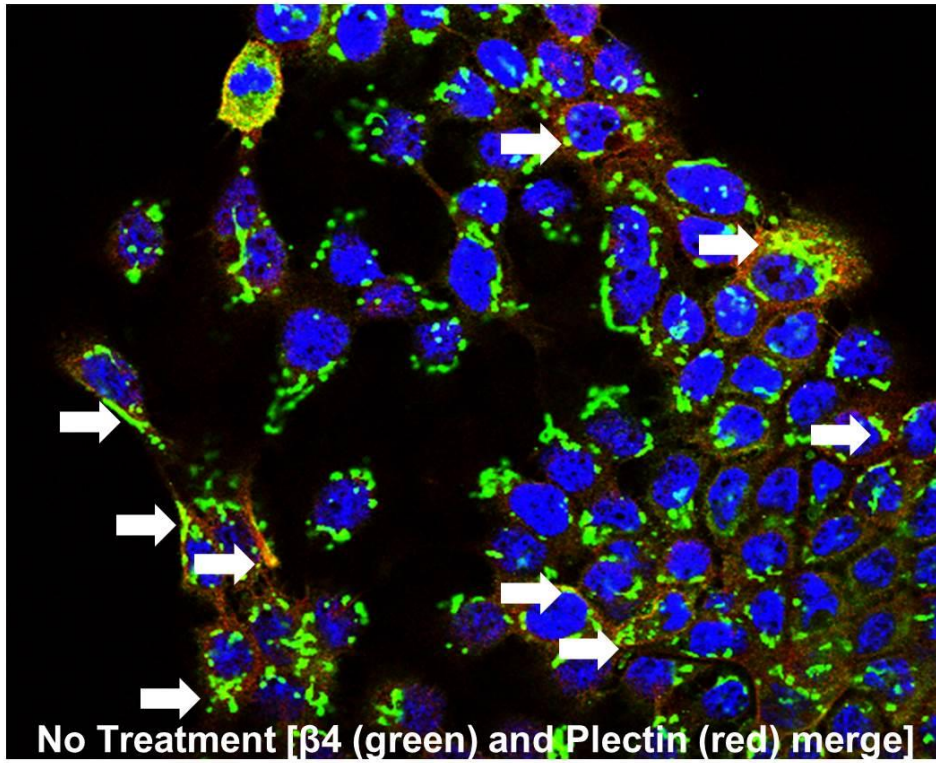

G)

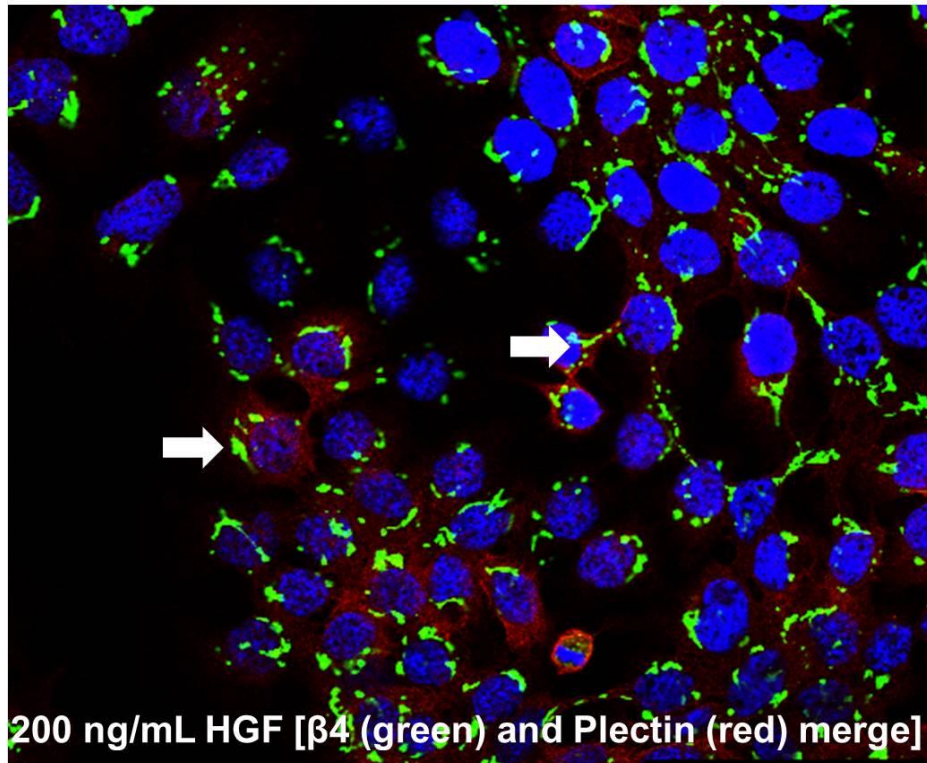

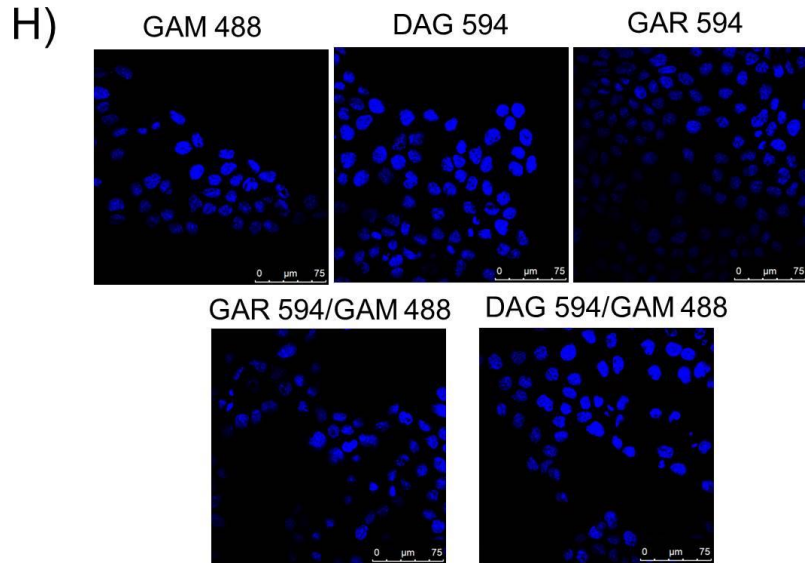

Figure 16. HGF Stimulation Disrupts the β 4/c-Met Association and Leads to Disassembly of Hemidesmosome-like Structures. Co-localization of β 4 with either c-Met or plectin is decreased with HGF treatment, indicating hemidesmosome-like structures are disassembled as assessed by confocal immunofluorescence. Images taken at 63x. White arrows indicate co-localization. A) β 4 (detected with Alexa Fluor GAM488, green) interaction with c-Met (Alexa Fluor DAR594, red) in non-treated and HGF-treated conditions. Enlarged merged images show β 4 co-localization with c-Met in B) non-treated and C) HGF-treated cells. The original image for parts B and C are in the upper left hand corner with the enlarged area outlined in white. D) β 4 protein levels do not decrease with HGF treatment (30 minutes). Western blot analysis of whole cell lysate. CHO lysate was run as a negative control for β 4 protein expression. E) β 4 co-localization with plectin (Alexa Fluor DAG594, red) in non-treated and HGF treated conditions. Enlarged merged images show β 4 co-localization with plectin in F) non-treated and G) HGF- treated cells. H) Secondary antibody controls for Figure 16 and 20.

β4 is activated by c-Met, resulting in 12-LOX recruitment but not 12-LOX enzymatic activation

Previously it was shown that c-Met activation leads to β4 phosphorylation (Bertotti et al. 2005; Bertotti et al. 2006; Trusolino et al. 2001). We confirmed this activation in A431 cells treated with increasing concentrations of HGF followed by immunoprecipitation of β4 by detecting global phosphorylated tyrosine using the PY20 antibody (Figure 17A). Our lab has shown that laminin or 3E1 direct stimulation of β4 leads to its activation and subsequent recruitment of 12-LOX to the integrin (Tang *et al.* manuscript pending). 3E1 is a well-established activator of β4 and has been shown to act similarly to laminin, the natural ligand (Mainiero et al. 1995). Specifically, we have shown that integrin stimulation using 3E1 resulted in β4 tyrosine 1494 (β4-Y1494) phosphorylation (Dilly *et al.* manuscript pending). Mutational analysis revealed this residue is critical for 12-LOX recruitment to β4 and therefore 12-LOX activation following integrin stimulation (Dilly *et al.* manuscript pending). β4-Y1494 is hypothesized to be a master regulator of β4 function (Dutta & Shaw 2008). When mutated, in addition to mutation of tyrosine 1257, overall β4 phosphorylation was decreased in response to constitutively active c-Met via overexpression through transfection (Bertotti et al. 2006). Therefore, this residue has been implicated, but never directly shown, in HGF activation of β4. Additionally, β4-Y1494 is known to be essential for β4-mediated carcinoma invasion (Shaw 2001). Mutation of β4-Y1494 inhibited ERK-mediated anchorage-independent growth of breast cancer cells *in vitro* along with PI3K and SRC-mediated tumor growth and angiogenesis *in vivo* (Dutta & Shaw 2008). Recently it was discovered that β4-Y1494 stimulates SHP2 catalytic activity by interacting with its N-terminal SH2 domain, which was required for β4-dependent invasion (Yang et al. 2010). SHP2 recruitment to β4 following c-Met activation was shown to be important for ERK signaling (Bertotti et al. 2006), which is known to be necessary for c-Met-mediated cell scattering and invasion (Hartmann

et al. 1994; Potempa & Ridley 1998; Ridley et al. 1995). Therefore, we assessed whether HGF stimulation could result in phosphorylation of $\beta 4$ -Y1494. Following cell treatment with HGF and immunoprecipitation of $\beta 4$, $\beta 4$ -Y1494 was indeed found to be activated compared to non-treated cells (Figure 17B). These results show that HGF induces $\beta 4$ phosphorylation, and specifically $\beta 4$ -Y1494 phosphorylation.

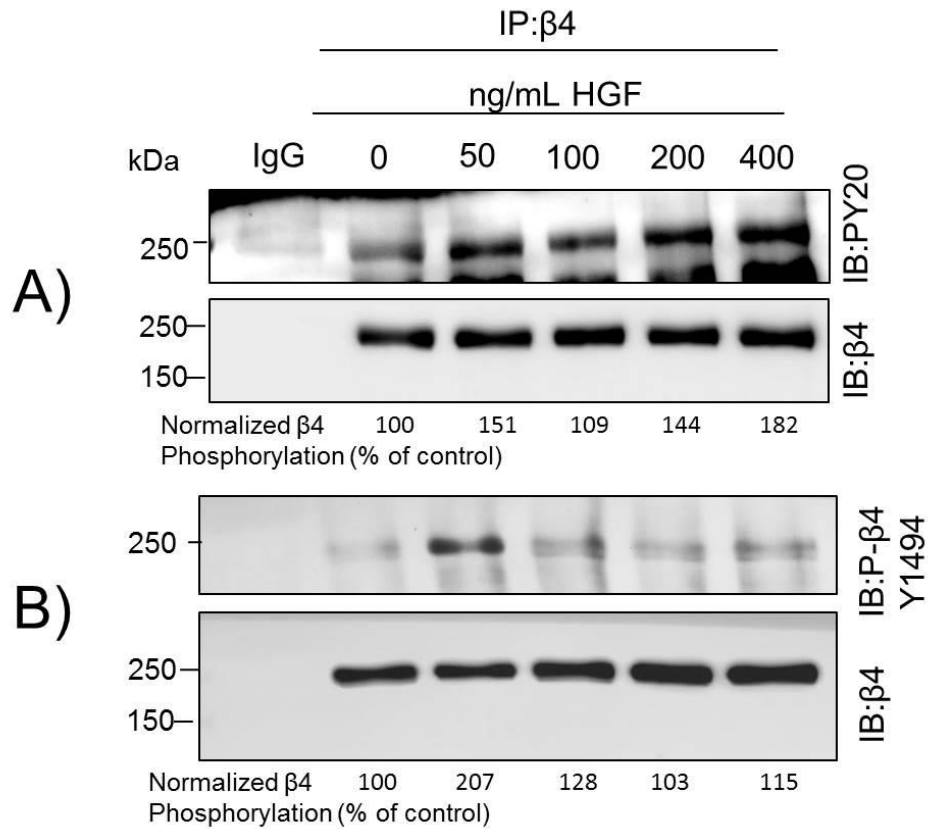

Figure 17. HGF Stimulation Leads to β4 Phosphorylation. Immunoprecipitation of β4 shows A) β4 tyrosine phosphorylation and B) β4-Y1494 phosphorylation is increased with HGF treatment (30 minutes; indicated concentrations). Western blot analysis for PY20 or phospho-β4-Y1494 respectively. The membranes were stripped and re-probed for total β4 (lower panel). Densitometry was calculated by taking the ratio of phosphorylated β4 or β4-Y1494 (upper panel) to total β4 (lower panel) and normalizing to the non-treated control. Matched IgG was immunoprecipitated as a control.

To prove it was HGF activation of c-Met that led to $\beta 4$ phosphorylation, we used the c-Met inhibitor INCB28060, also known as INC280. This ATP competitive inhibitor was shown to be 10,000 fold more selective for c-Met versus other human kinases (Liu et al. 2011). First, we performed a dose-dependent assay to determine what concentration of INC280 was sufficient to inhibit HGF-induced c-Met phosphorylation. Cells were treated with increasing concentrations of the inhibitor for two hours prior to treatment with HGF, and activated c-Met was detected with a phospho-specific c-Met antibody by Western blot. With 100 nM INC280, the levels of HGF-induced phosphorylated c-Met were decreased significantly compared to HGF treatment alone (Figure 18A). At this concentration, c-Met phosphorylation was decreased even below the levels seen in non-treated cells. There is basal c-Met activation in A431 cells and is likely due to constitutively active EGFR in these cells, as EGFR can cross activate c-Met (Jo et al. 2000). Next, we treated cells with 100 nM INC280 and looked to see if this affected HGF-induced $\beta 4$ phosphorylation by immunoprecipitating for $\beta 4$ followed by Western blot analysis using PY20 antibody. With HGF stimulation, significant $\beta 4$ phosphorylation occurred. However, pre-treatment of cells with the c-Met inhibitor completely abrogated the activation (Figure 18B). Therefore, HGF activation of c-Met leads to the cross-activation of $\beta 4$.

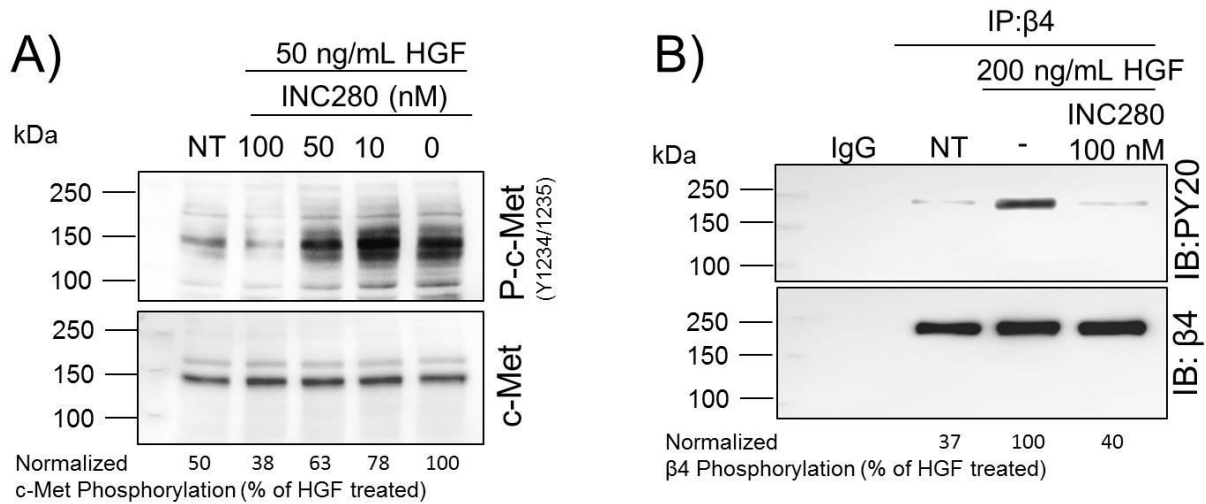

Figure 18. The c-Met Inhibitor INC280 Reveals HGF Activation of c-Met Leads to β 4 Activation. A) Dose-dependent assay to determine the concentration of INC280 required to prevent HGF-induced c-Met phosphorylation. Cells were pre-treated for two hours with INC280 at the indicated concentrations and then stimulated with 50 ng/mL HGF for 30 minutes. Phosphorylated (upper panel) and total c-Met (lower panel) were analyzed by Western blot. Densitometry represents the ratio of phosphorylated to total c-Met as a percentage of the HGF treated control (last lane; upper panel). B) 100 nM INC280 inhibits HGF-induced β 4 phosphorylation. Cells were pre-treated with INC280 for two hours before HGF stimulation (30 minutes; 200 ng/mL). Lysates were immunoprecipitated for β 4 followed by Western blot analysis with PY20 to assess for phosphorylated β 4. The membrane was stripped and re-probed for total β 4 (lower panel). Densitometry was calculated by taking the ratio of phosphorylated β 4 (upper panel) to total β 4 (lower panel) and normalizing to the non-treated control. Immunoprecipitation of matched IgG was performed as a control.

Given that $\beta 4$ is activated after HGF treatment, we wanted to determine whether this results in 12-LOX recruitment to the integrin. In parallel, direct activation of $\beta 4$ by either 3E1 or laminin causes 12-LOX recruitment to $\beta 4$ and subsequent activation of the enzyme resulting in 12(S)-HETE production (Figure 19). Platelet type 12-LOX expression has been confirmed in A431 cells (Tang et al. 2000). After immunoprecipitation for $\beta 4$ in A431 cells, 12-LOX interacted with $\beta 4$ at levels barely detectable in serum-starved and basal conditions, but the association was increased after HGF treatment compared to the 3E1 treated positive control (Figure 20A). Human platelets express high levels of 12-LOX, therefore platelet lysate was loaded as a running control. In the reciprocal immunoprecipitation, pull-down for 12-LOX also showed $\beta 4$ interaction with the enzyme in cells treated with HGF (Figure 20B). Immunofluorescence results confirm the immunoprecipitation data, where there was limited $\beta 4$ (green) and 12-LOX (red) co-localization in serum-starved cells, but their interaction was increased with HGF stimulation (Figure 20C-E).

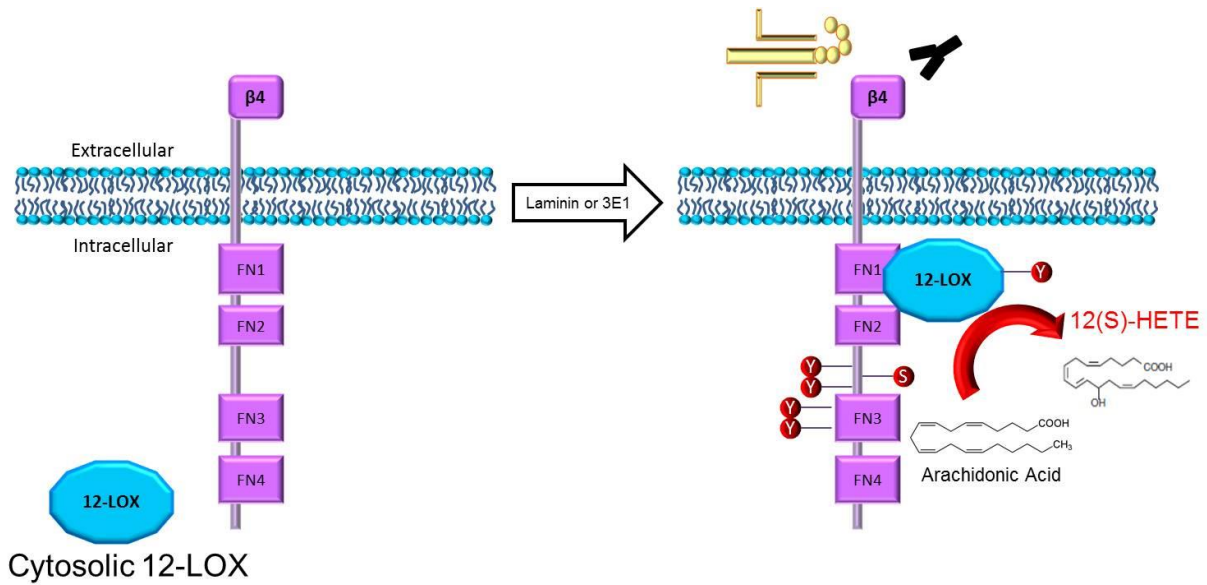

Figure 19. Schematic of 12-LOX Activation Following β_4 Stimulation. In resting cells, 12-LOX is mostly cytoplasmic and is not enzymatically active. Following β_4 stimulation with either laminin or 3E1, 12-LOX translocates from the cytosol to the membrane where it interacts with β_4 . Subsequently, 12-LOX is phosphorylated by SRC and is activated to produce 12(S)-HETE from AA.

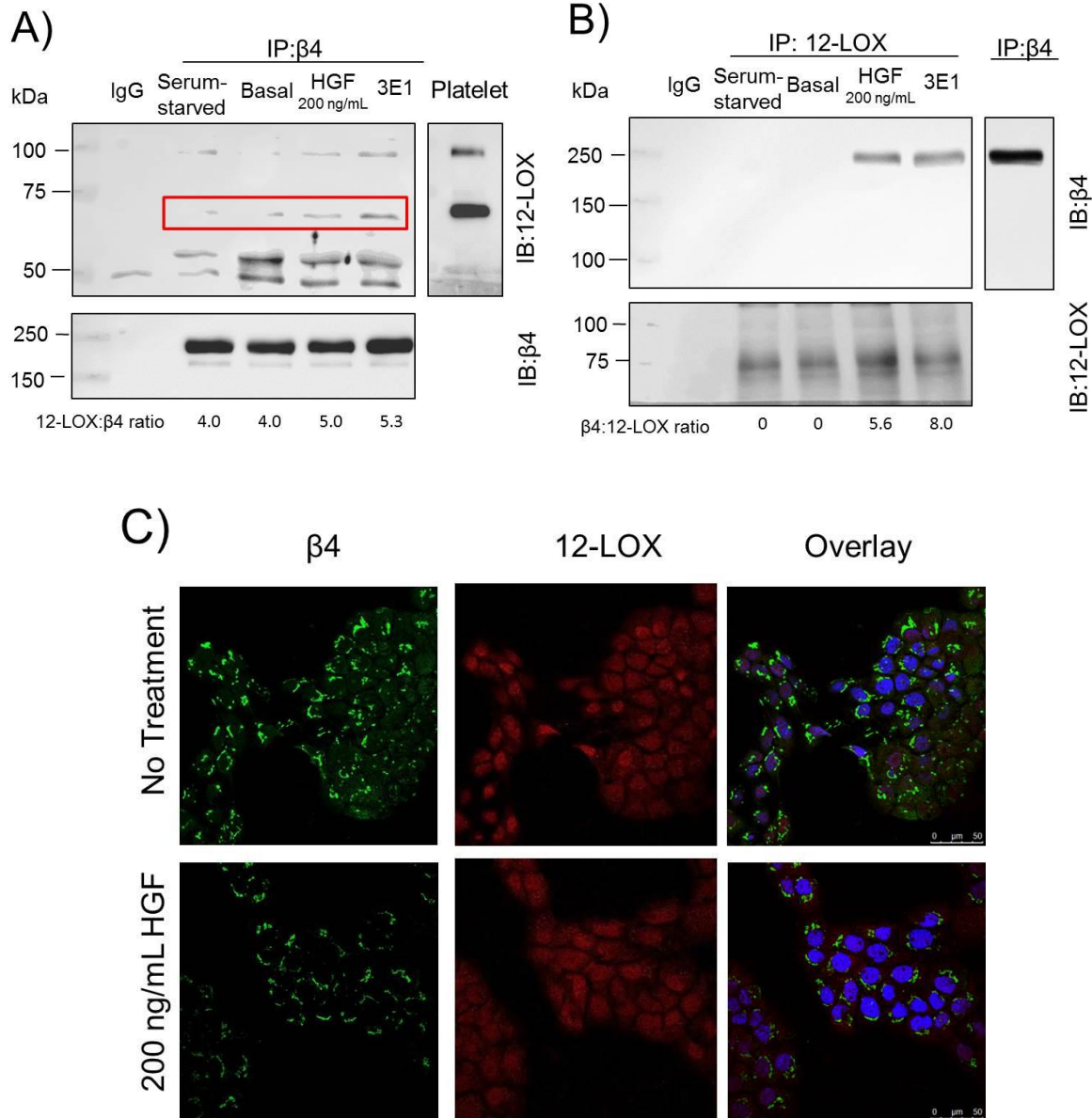
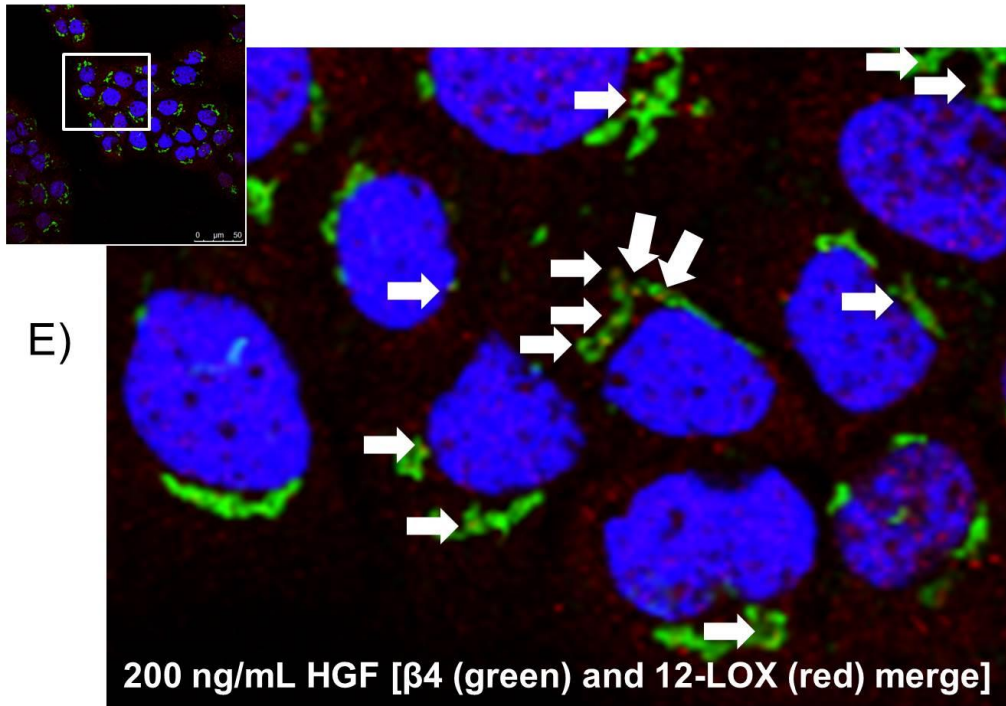
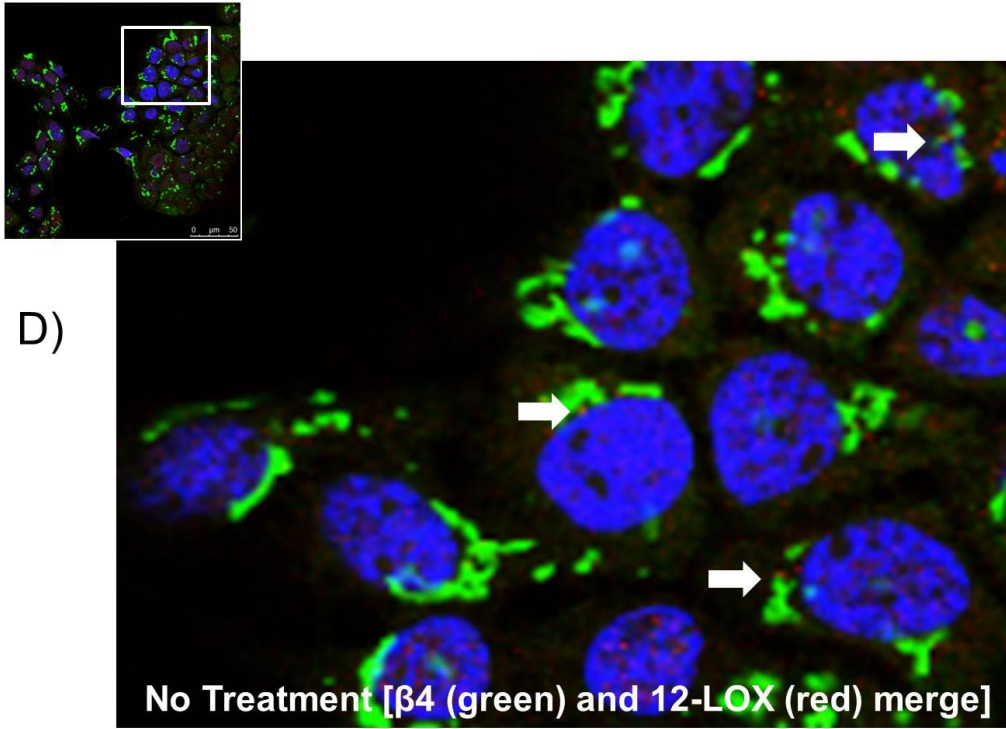

Figure 20. HGF Stimulation Leads to 12-LOX Recruitment to $\beta 4$. A&B: 12-LOX and $\beta 4$ interact with HGF stimulation (30 minutes) similar to the 3E1 positive control. Densitometry analysis represents the ratio of the co-immunoprecipitated protein (upper panel) to pulled-down protein (lower panel). Immunoprecipitation of matched IgG was performed as a control. A) Immunoprecipitation of $\beta 4$ followed by Western blot analysis for 12-LOX. Platelet whole cell lysate was run as a control. The membrane was stripped and re-probed for total $\beta 4$ (lower panel). B) Reciprocal immunoprecipitation of part A. Immunoprecipitation for $\beta 4$ (last lane; upper panel) was run as a control for co-immunoprecipitated $\beta 4$ and exposed for a shorter duration due to band intensity. The membrane was stripped and re-probed for total 12-LOX (lower panel). C) Confocal immunofluorescence showing 30 minute HGF treatment leads to increased 12-LOX (Alexa Fluor DAG594, red) and $\beta 4$ (Alex Fluor GAM488, green) co-localization. Images taken at 63x. Enlarged merged images show $\beta 4$ co-localization with 12-LOX, indicated by white arrows, in D) non-treated and E) HGF treated cells. The original image for parts D and E are in the upper left hand corner with the enlarged area outlined in white.



As HGF stimulation caused recruitment of 12-LOX to β 4, we next wanted to test whether this resulted in 12-LOX enzymatic activation. A431 cells were incubated with AA, the substrate for 12-LOX metabolism of 12(S)-HETE. At the experiment end point, lipids were isolated by solid phase extraction from cell-conditioned media and analyzed by LC-MS. The results indicate that both 6 and 24 hour HGF treatment actually suppressed 12-LOX enzymatic activity, compared to the 3E1 positive control and AA treatment alone (Figure 21). This result lead us to hypothesize that in addition to its enzymatic action, 12-LOX may also play a novel role as a scaffold between β 4 and c-Met to promote HGF-induced invasion through the cross-activation of β 4 by activated c-Met with HGF stimulation.

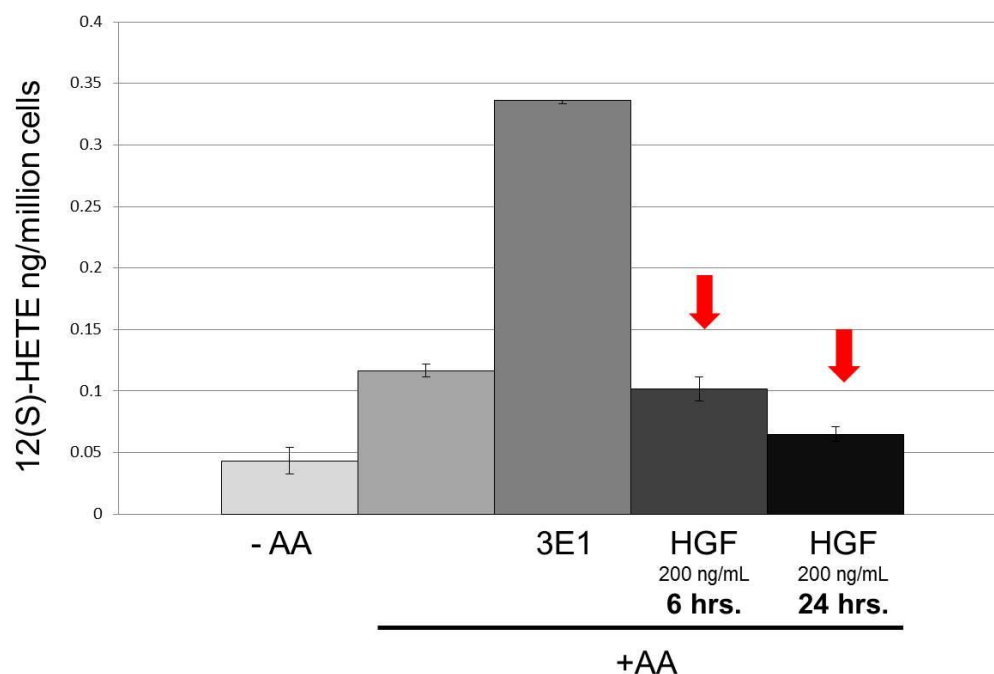

Figure 21. HGF Stimulation Does Not Result in 12-LOX Enzymatic Activation. 12(S)-HETE levels measured in conditioned media using LC-MS indicate HGF does not activate 12-LOX enzymatic activity. Cells were treated with HGF and AA for the indicated times. 3E1 treatment was used as a positive control for 12(S)-HETE production. Lipids were extracted as per standard protocols (see Materials and Methods). The data were analyzed in triplicate and error bars represent SEM.

12-LOX is required for HGF-induced β 4 activation

To elucidate the role of 12-LOX in β 4 and c-Met axis crosstalk, we utilized the previously characterized A431 12-LOX knockdown (KD) cells (Figure 7). Knockdown of 12-LOX was achieved through stable expression of shRNA targeted to 12-LOX and was confirmed at the protein level (Figure 22A). Immunoprecipitation of β 4 was performed to ensure that 12-LOX no longer co-immunoprecipitated with β 4 following 3E1 stimulation in the 12-LOX KD cell line (Figure 22B). As expected, 12-LOX does not pull-down with β 4 in the 12-LOX KD cells compared to the ns shRNA cells.

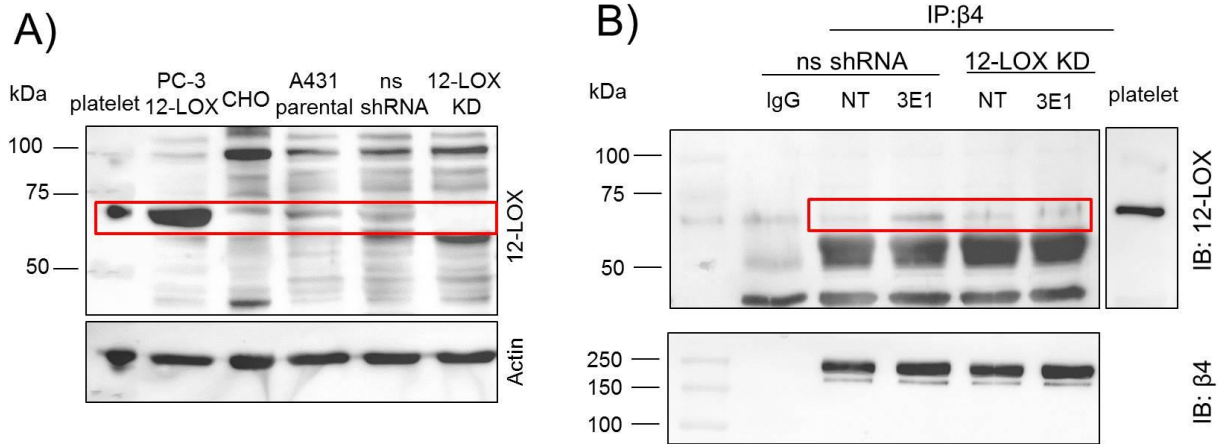

Figure 22. Confirmation of 12-LOX Knockdown. A) Western blot analysis of 12-LOX protein levels in the following cell lines: 12-LOX KD (#1 clone), ns shRNA control, parental A431, CHO (negative control for 12-LOX expression; Santa Cruz polyclonal platelet-type 12-LOX antibody appears to be recognizing another 12-LOX isoform in CHO cells; band is slightly higher than that of platelet 12-LOX), PC-3 12-LOX overexpressors (positive control for 12-LOX), and platelet lysate (positive control for 12-LOX expression). B) 12-LOX was not recruited to $\beta 4$ with 3E1 stimulation (30 minutes) in the 12-LOX KD cells compared to the ns shRNA control cells. Immunoprecipitation of $\beta 4$ followed by Western blot analysis for 12-LOX (upper panel). The membrane was stripped and re-probed for total $\beta 4$ (lower panel). Immunoprecipitation of matched IgG was performed as a control. Platelet whole cell lysate was run as a positive control for 12-LOX (last lane; upper panel).

To determine if 12-LOX is required for the cross-activation of $\beta 4$ by c-Met, A431 12-LOX KD cells and ns shRNA control cells were treated with increasing concentrations of HGF followed by immunoprecipitation for $\beta 4$. Unlike the controls where HGF stimulation resulted in $\beta 4$ tyrosine phosphorylation, as measured with PY20, no increase in $\beta 4$ activation was seen in the 12-LOX KD cells (Figure 23A). Additionally, HGF treatment induced $\beta 4$ -Y1494 phosphorylation to the level of 3E1 treatment in the ns shRNA control cells, yet there was no activation above that seen in the non-treated control in the 12-LOX KD cells with either HGF or 3E1 (Figure 23B).

Downstream of 3E1 activation of $\beta 4$, recruitment and enzymatic activation of 12-LOX, 12(S)-HETE acts back on its receptor, 12HETER-1, to activate MAPK signaling (Guo et al. 2011b; Pidgeon et al. 2007). Using the 12-LOX KD cell line, 12-LOX was shown to be required for $\beta 4$ -mediated downstream signaling to ERK and also shown to promote $\beta 4$ -mediated, EGF-stimulated cellular invasion using the 12-LOX specific inhibitor BMD122 (Figures 8&9). In the 12-LOX KD cells, inhibited $\beta 4$ activation in response to HGF lead to suppressed downstream ERK and AKT activation compared to the ns shRNA control cells (Figures 23C&D). These results strongly suggest that 12-LOX is required for HGF-induced $\beta 4$ phosphorylation and HGF-induced $\beta 4$ downstream signaling to AKT and ERK.

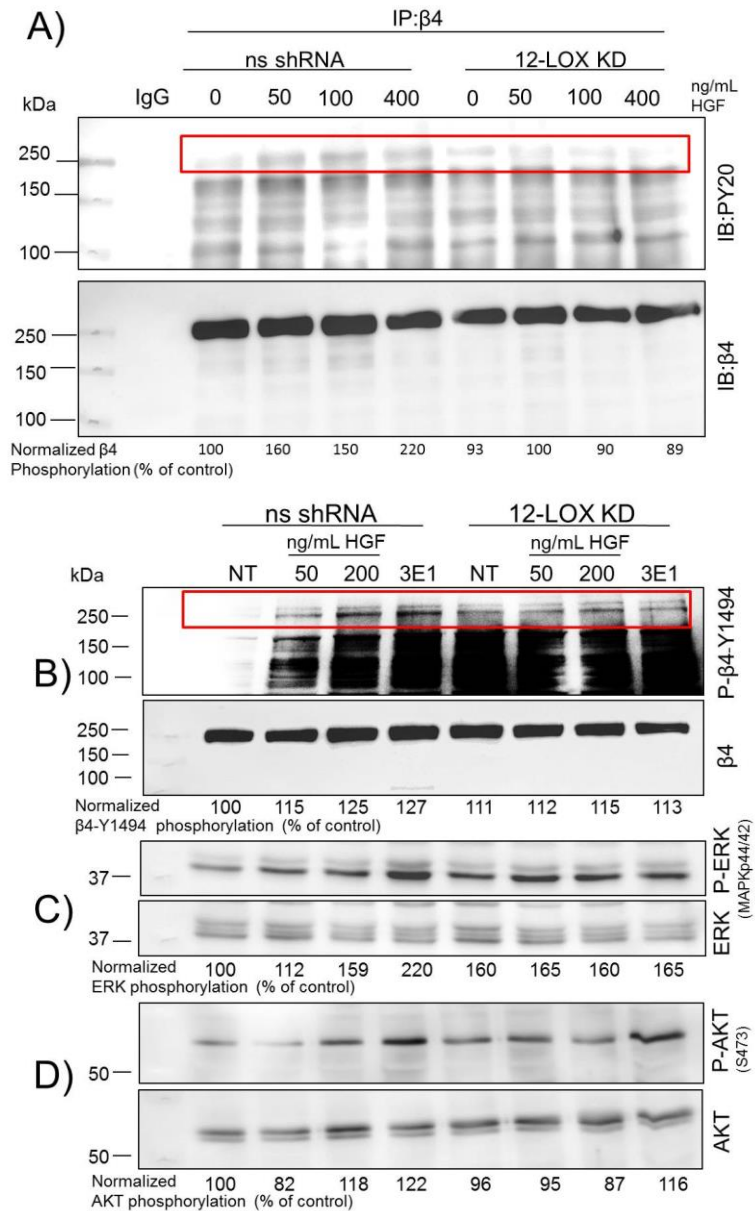

Figure 23. 12-LOX is Required for HGF-induced β4 Phosphorylation and Downstream Signaling. A) β4 is not phosphorylated following HGF treatment (30 minutes) in the 12-LOX KD cells. Immunoprecipitation of β4 followed by Western blot analysis with PY20 (upper panel). The membrane was stripped and re-probed for total β4 (lower panel). Densitometry analysis represents the ratio of phosphorylated β4 to total β4 normalized to the non-treated control. Immunoprecipitation of matched IgG was performed as a control. B-D: Western blot analysis of 12-LOX KD cells shows decreased B) β4-Y1494, C) ERK, and D) AKT phosphorylation in response to HGF stimulation (30 minutes) compared to ns shRNA control cell lysates. 3E1 stimulation was used as a positive control. Densitometry represents the ratio of phosphorylated (upper panel) to total protein (lower panel) normalized as a percentage to the non-treated control in the ns shRNA cells.

Because 12-LOX is required for HGF-induced β 4 phosphorylation, we wanted to test if 12-LOX was scaffolding β 4 and c-Met directly to permit cross-activation. Both immunoprecipitation for β 4 and the reciprocal immunoprecipitation for c-Met show that the β 4/c-Met complex is undisturbed in serum-starved cells (NT = no treatment) and HGF leads to their dissociation in both the 12-LOX KD and ns shRNA control cells (Figure 24A&B). These data show that 12-LOX is required for mediating β 4 tyrosine phosphorylation following HGF treatment as well as promoting β 4 downstream signaling to ERK and AKT, but that the enzyme does not appear to scaffold β 4 and c-Met directly.

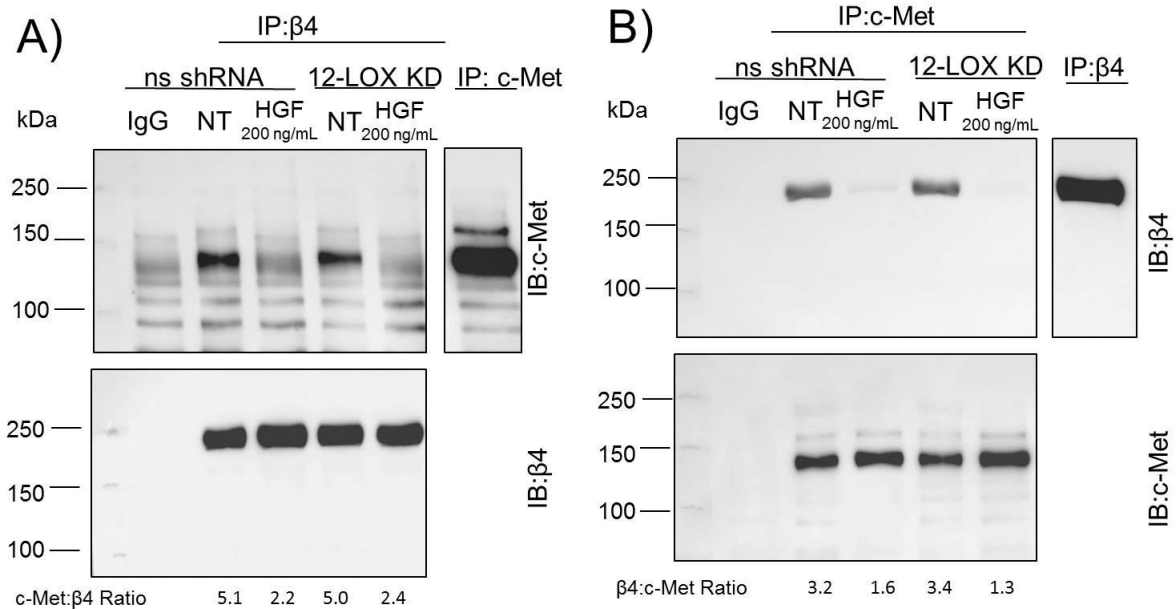

Figure 24. 12-LOX is Not Required for β 4 and c-Met Association. 12-LOX KD does not affect c-Met and β 4 interaction in the no treatment (NT) condition, nor does it affect their dissociation with HGF treatment (30 minutes). Densitometry represents the ratio of co-immunoprecipitated protein (upper panel) to pulled-down protein (lower panel). Immunoprecipitation of matched IgG was performed as a control. Immunoprecipitation of the co-immunoprecipitated protein was performed as a positive control and exposed for a shorter duration due to band intensity (last lane; upper panel). A) Immunoprecipitation of β 4 in 12-LOX KD and ns shRNA control cells followed by Western blot analysis for c-Met. The membrane was stripped and re-probed for total β 4 (lower panel). B) Reciprocal immunoprecipitation of part A.

12-LOX promotes HGF-induced cell scattering and invasion

Our demonstration that cross-activation of $\beta 4$ by c-Met depends on the presence of 12-LOX led to the hypothesis that $\beta 4$ can act as a signaling adapter for c-Met. To test this, we assayed whether 12-LOX has any functional impact on HGF-induced cell scattering and invasion. Integrins have been implicated specifically in cell scattering and migration induced by HGF. HGF promotes integrin adhesion to laminins 1 and 5, which results in increased invasiveness, shown to be mediated by multiple integrins, including $\beta 4$, using function-blocking antibodies (Trusolino et al. 2000). This HGF-promoted integrin adhesion occurs concomitantly with hemidesmosome disassembly in cellular migration. Additionally, Ras is activated downstream of c-Met and is required for cell scattering (Hartmann et al. 1994; Potempa & Ridley 1998; Ridley et al. 1995). Due to the observed inhibited ERK activation in 12-LOX KD cells with HGF (Figure 23), cell scattering of parental A431, 12-LOX KD, and ns shRNA control cells were compared. Cells were seeded at a low density into 96 well plates and after colony formation on day seven were serum-starved overnight followed by HGF treatment for 16 hours. With increasing concentrations of HGF stimulation, parental A431 cell colonies were disrupted as the cells began to migrate or ‘scatter’ away from one another (Figure 25A). This effect was increasingly evident at and above 100 ng/mL HGF and can be seen quantified as the number of colonies remaining after HGF treatment in Figure 25B. Compared to the ns shRNA control cells, 12-LOX KD cells remained in tightly packed islands and were almost completely resistant to the HGF stimulus. Even at the highest concentration of HGF (400 ng/mL) there was a colony responding to HGF by scattering, severely contrasted by a neighboring colony that was clearly non-responsive in the 12-LOX KD cell line. Similar to the cell scatter effect, the 12-LOX KD cells displayed a significant reduction in response to HGF-induced invasion compared to the ns shRNA controls (Figure 25C), further supporting our

hypothesis that 12-LOX may be acting as a scaffold in cooperation with $\beta 4$ to enhance c-Met-mediated functions. As another control, we added 12(S)-HETE with HGF and found this does not significantly rescue the reduced invasion, again suggesting 12-LOX enzymatic activity plays no role in c-Met-mediated invasion. As yet another control, we assayed for 12HETER-1 expression by Western blot to ensure that A431 cells express the receptor. As seen in Figure 25D, A431 cells express 12HETER-1 compared to the prostate cancer cell line controls, which are all known to express it. The positive control was whole cell lysate from bacterial cells transformed with 12HETER-1 (last lane). The bands corresponding to the receptor in the bacterial cell whole cell lysate are smaller in size than what is seen in the human cell lines due to differences in glycosylation between bacteria and mammals.

In the scatter assay, to eliminate the possibility that the cells were merely migrating toward one another because the colonies were close in proximity due to high confluence levels, the assay was repeated where the cells were grown for four days instead of seven, leading to both fewer and smaller colonies (Figure 25E). Only two concentrations of HGF were tested, but again, the colonies in the 12-LOX KD cells were unresponsive to HGF stimulation, as most of the colonies remained un-scattered (Figure 25F). At the highest concentration of HGF in the A431 parental and ns shRNA control cells, most of the colonies were scattered into single cells. These results show that 12-LOX promotes HGF-induced, c-Met-mediated cell scattering and invasion.

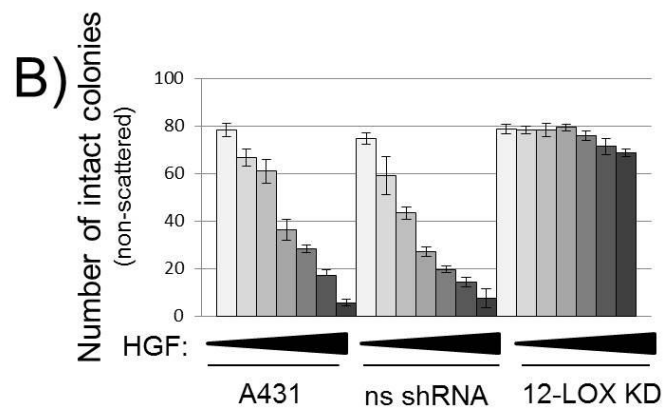
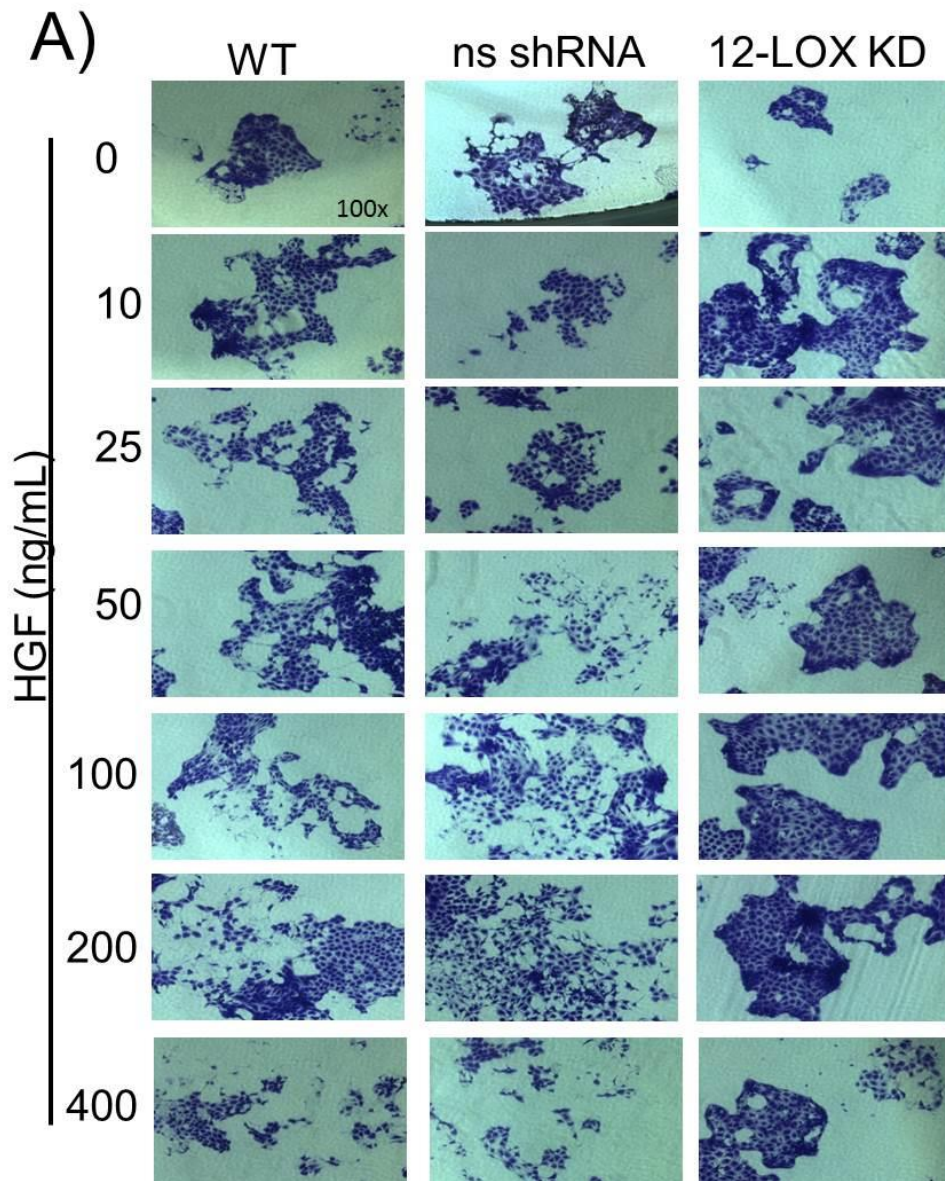

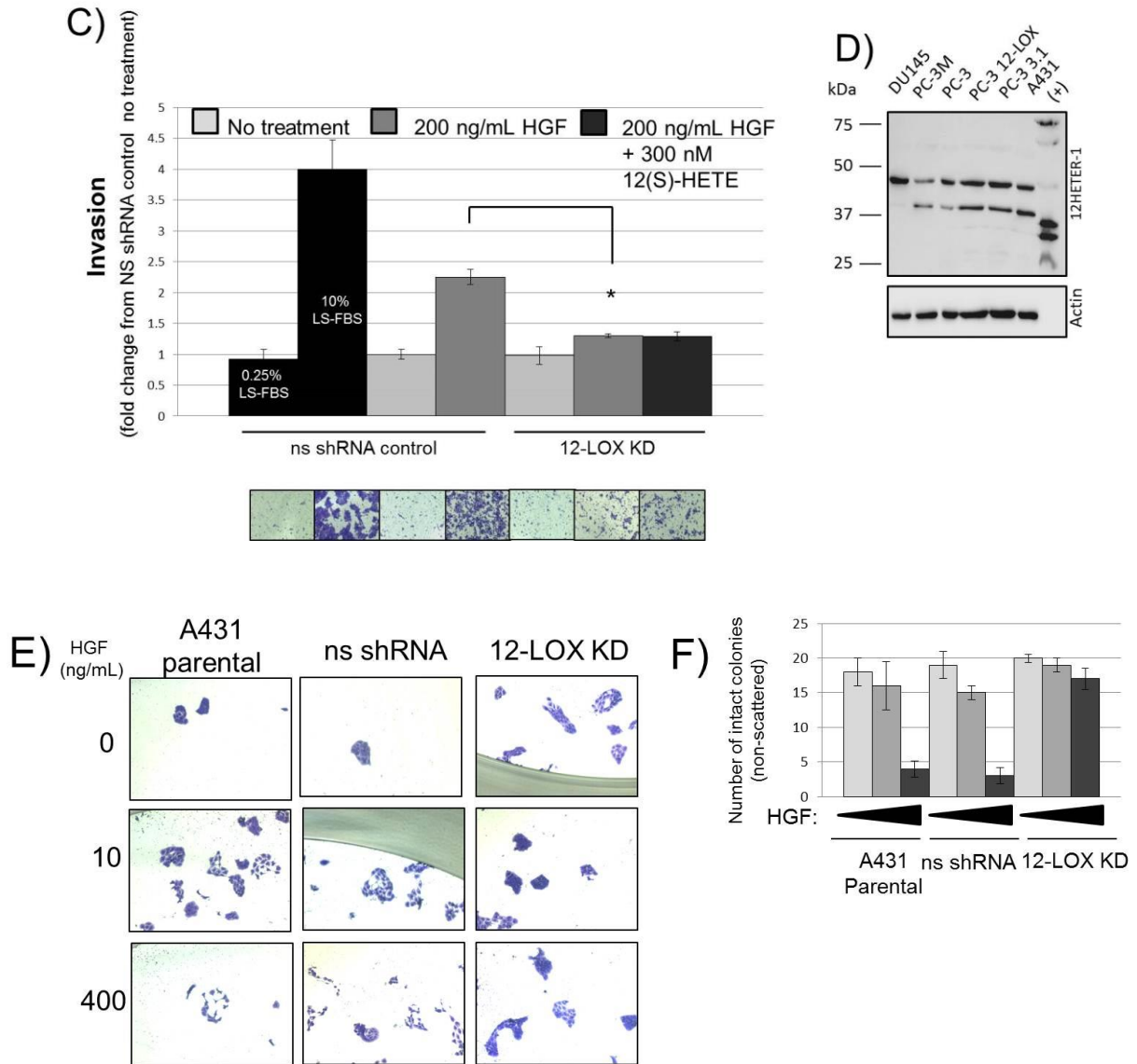

Figure 25. 12-LOX Regulates HGF-induced Cell Scatter and Invasion. A) 12-LOX is required for HGF-induced cell scattering. Scatter assay of 12-LOX KD, ns shRNA control, and A431 parental cells. Cells were seeded at a low density, allowed to form colonies for seven days, were serum-starved overnight, and treated with increasing concentrations of HGF for 16 hours. Images taken at 100x. B) Quantitation of intact/HGF-non-responsive colonies from part A, counted in triplicate +/- SEM. C) 12-LOX KD cells have a reduced capacity to invade with HGF stimulation compared to ns shRNA control cells, an effect that is not rescued by 12(S)-HETE add-back. Cells invaded through a Boyden chamber coated with Matrigel for 18 hours in response to the indicated treatments. 0.25% lipid stripped FBS and 10% FBS were run as negative and positive controls respectively. Invasion was quantified by measuring the absorbance at 570nm of the crystal violet stain extracted from invaded cells. * $p < 0.05$, student's T-test, bars represent the average of three trials. D.) Western blot analysis of 12HETER-1 in whole cell lysate from several prostate cancer cell lines, A431 cells, and the positive control bacterial cells transformed with the receptor. E) Replication of scatter assay in part A after four days of colony formation instead of seven. F) Quantitation of intact/HGF-non-responsive colonies from part E, counted in triplicate +/- SEM.

Inhibition of 12-LOX interaction with β 4 using FNO1 or FNO1-2 peptides hampers HGF-induced cell scattering and invasion

To validate the importance of 12-LOX in HGF-mediated functioning seen using the 12-LOX KD cells, we transfected two different peptides, FNO1 and FNO1-2, into wild type A431 cells to inhibit 12-LOX interaction with β 4 through competitive binding. Sequential mutagenesis of the β 4 cytoplasmic tail previously revealed that 12-LOX interacts within the GR16 region of β 4 (Joshi *et al.* manuscript pending) (Figure 10). Further analysis showed 12-LOX interacts within FNO1, a 23 amino acid peptide of GR16 (1126-1315) identical to β 4 residues 1126-1157 of the first and second FNIII repeats on the cytoplasmic tail of β 4. Fine mapping studies showed 12-LOX binds β 4 within FNO1-2 (1137-1147), a sequence found within FNO1. These peptides presented a novel way to validate the results from the 12-LOX KD cells and also to test whether using them may prove therapeutically efficacious in targeting c-Met signaling. Immunoprecipitation results confirm that transfection of cells with either FNO1 or FNO1-2 using the Chariot reagent for six hours led to decreased 12-LOX association with β 4 compared to the scrambled control (Figure 26). We also confirmed that cell transfection with FNO1 and/or FNO1-2 suppressed HGF-induced β 4 phosphorylation and HGF-induced, β 4-mediated downstream signaling to AKT and ERK (Figure 27). Similar to the 12-LOX KD effect, the FNO1/FNO1-2 peptides inhibited 3E1-induced, β 4-mediated signaling to AKT and ERK. Transfection efficiency, monitored using β -galactosidase staining, ranged from 50-70% and is most likely the cause of the residual 12-LOX and β 4 interaction leading to some β 4 phosphorylation and downstream signaling with HGF stimulation.

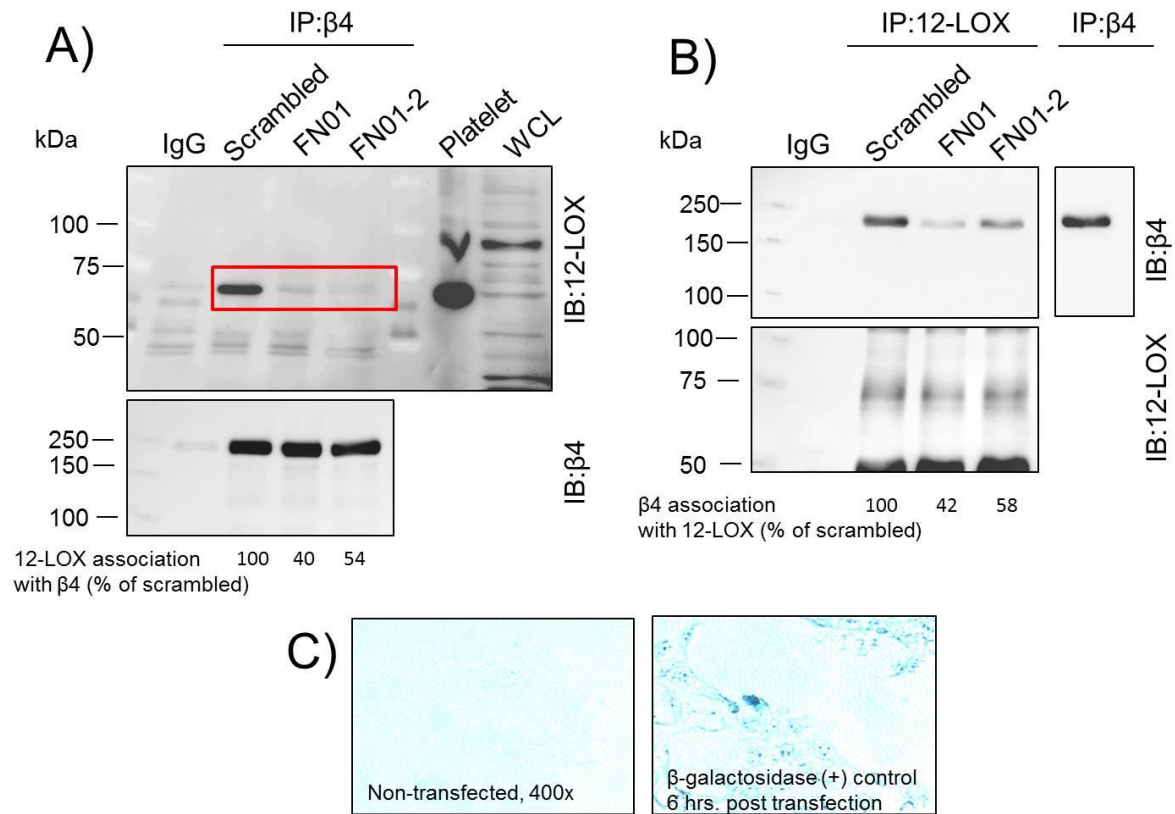

Figure 26. FNO1 and FNO1-2 Peptides Decrease β4 and 12-LOX Interaction. FNO1 and FNO1-2 peptides reduce 12-LOX interaction with β4. Immunoprecipitation of matched IgG was performed as a control. Densitometry represents the ratio of co-immunoprecipitated protein (upper panel) to pulled-down protein (lower panel) normalized to the scrambled control. A) Immunoprecipitation of β4 in A431 cells transfected with scrambled, FNO1, or FNO1-2 peptides for six hours using Chariot reagent followed by Western blot analysis for 12-LOX (upper panel). The blot was stripped and re-probed for total β4 (lower panel). Platelet and A431 parental whole cell lysates were run as a control for 12-LOX. B) Reciprocal immunoprecipitation of part A. Immunoprecipitation of β4 (last lane; upper panel) was run as a positive control for co-immunoprecipitated β4 and exposed for a shorter duration due to band intensity. C). β-galactosidase staining was used to monitor transfection efficiency of peptides.

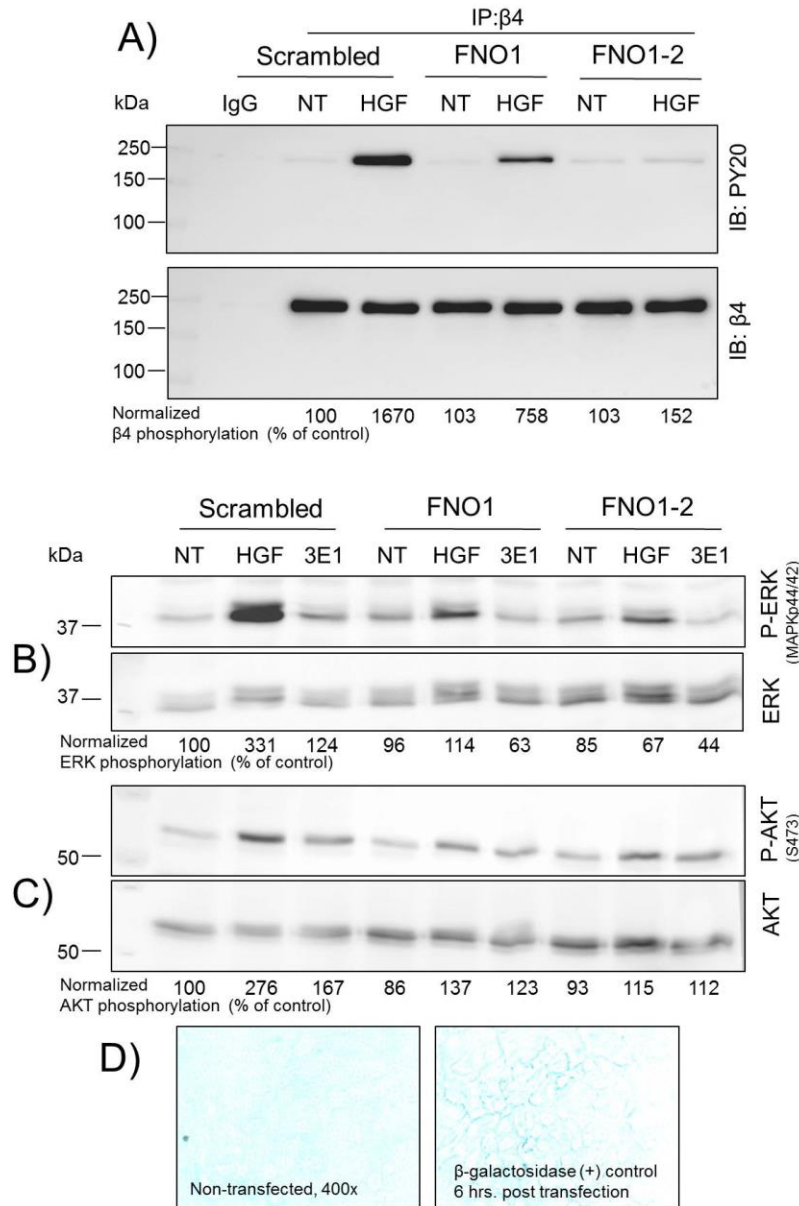

Figure 27. FNO1 and FNO1-2 Peptides Suppress HGF-induced β4 Phosphorylation and Downstream Signaling. A) Immunoprecipitation of β4 in A431 cells transfected with scrambled, FNO1, or FNO1-2 peptides for six hours using Chariot reagent, treated with HGF (30 minutes; 200 ng/mL), followed by Western blot analysis for PY20 (upper panel). The blot was stripped and re-probed for total β4 (lower panel). Immunoprecipitation of matched IgG was performed as a control. Densitometry represents the ratio of phosphorylated β4 (upper panel) to total β4 (lower panel) normalized to the scrambled control. B&C: FNO1 and FNO1-2 peptides suppress HGF-induced, β4-mediated downstream signaling to ERK and AKT. Cells were transfected with peptides for six hours using Chariot reagent and then treated with HGF or 3E1 (30 minutes; 200 ng/mL HGF). Densitometry represents phosphorylated (upper panel) to total protein (lower panel). B) ERK and C) AKT activation were assessed by Western blot. D) β-galactosidase staining was used to monitor transfection efficiency of peptides.

Not only did the peptides recapitulate 12-LOX KD results in terms of cell signaling, but transfection of cells with FNO1 or FNO1-2 lead to a dramatic increase in the number of colonies remaining intact with HGF stimulation in the same scatter assay described previously (Figure 28A). In fact, peptide inhibition of 12-LOX interaction with β 4 lead to an approximate 30% increase in the number of intact or non-scattered colonies at the higher concentrations of HGF compared to cells transfected with scrambled peptide (Figure 28B). The cells were seeded at a low density, serum-starved overnight, transfected with peptides for six hours, and then treated with increasing concentrations of HGF. Transfection efficiency again was monitored with β -galactosidase staining (Figure 28C). Cell transfection with FNO1 and FNO1-2 significantly decreased HGF-induced invasion compared to the scrambled controls, indicating again that 12-LOX interaction with β 4 enhances c-Met-mediated cell motility and invasion (Figure 28D). As before, 12(S)-HETE add back with HGF did not rescue the reduced invasion seen with peptide treatment.

Replication of the scatter assay where the cells were grown for four days instead of seven, leading to both fewer and smaller colonies, also confirmed that cell transfection with FNO1 or FNO1-2 inhibited cell scattering by almost 50% (Figure 28F&G). All together these results demonstrate that 12-LOX is important for HGF-induced, c-Met-mediated cell scattering and invasion in cancer cells.

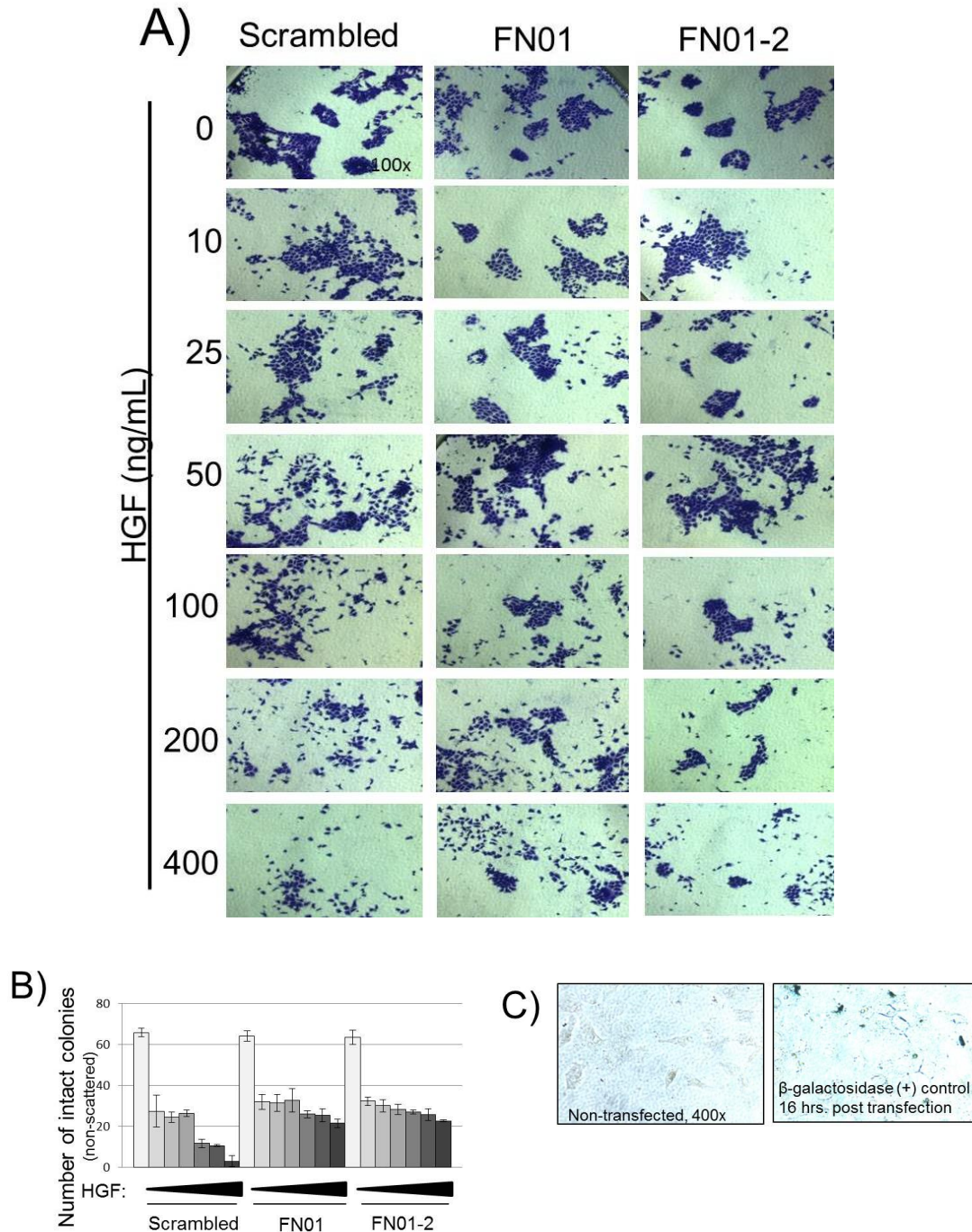

Figure 28. Inhibition of $\beta 4$ and 12-LOX Interaction, by FNO1 or FNO1-2 Peptides, Decreased HGF-induced Cell Scattering and Invasion. A) A431 cells transfected with FNO1 and FNO1-2 peptides show decreased cell scattering with HGF treatment compared to the scrambled control. Cells were seeded at a low density, allowed to form colonies for seven days, serum-starved overnight, transfected with the indicated peptides using Chariot reagent for six hours, and treated with increasing concentrations of HGF for 16 hours. Images taken at 100x. B) Quantitation of intact/HGF-non-responsive colonies from part A, counted in triplicate \pm SEM. C) β -galactosidase staining used to monitor transfection efficiency of peptides for scatter assay.

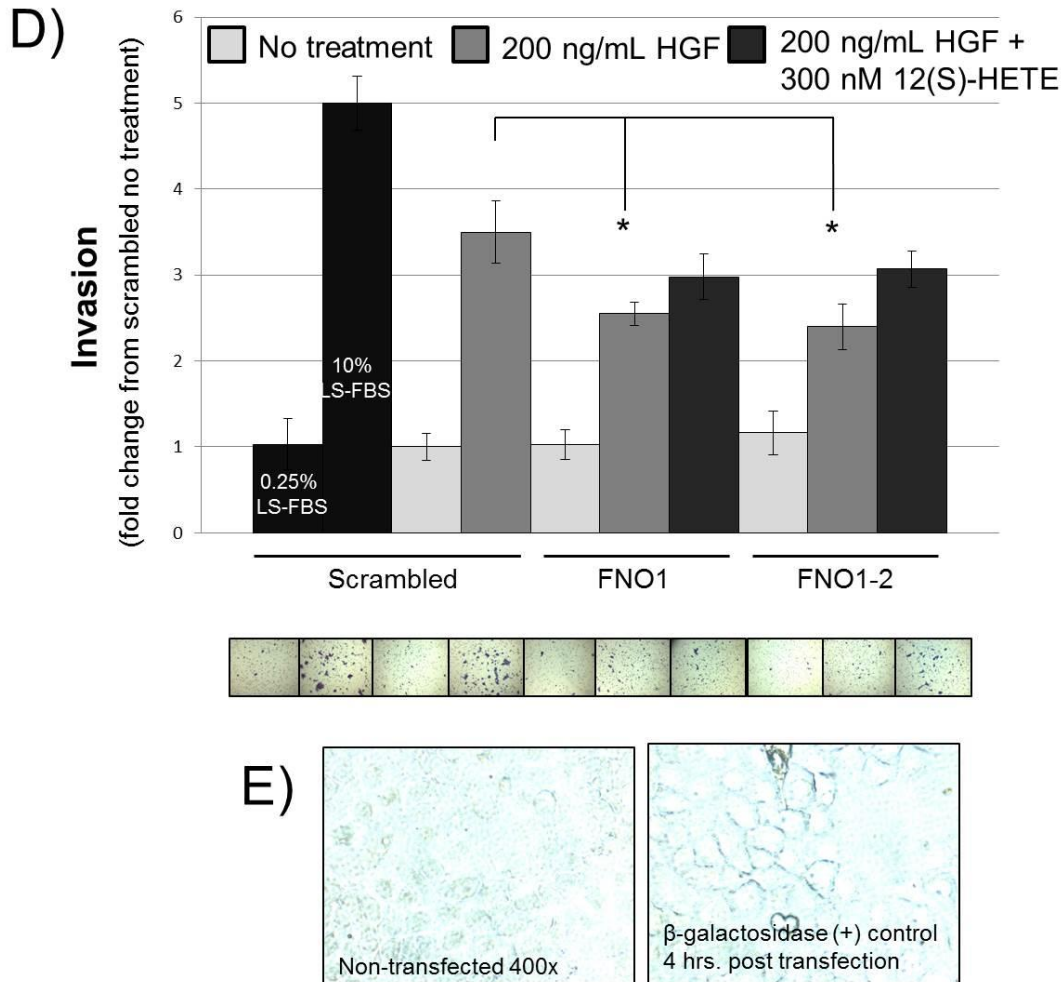
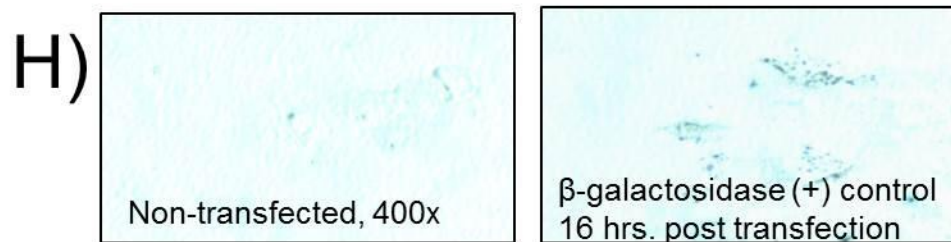
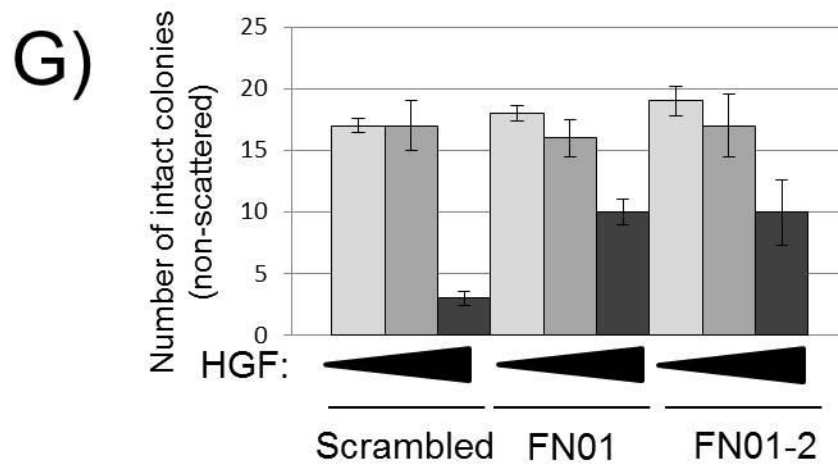
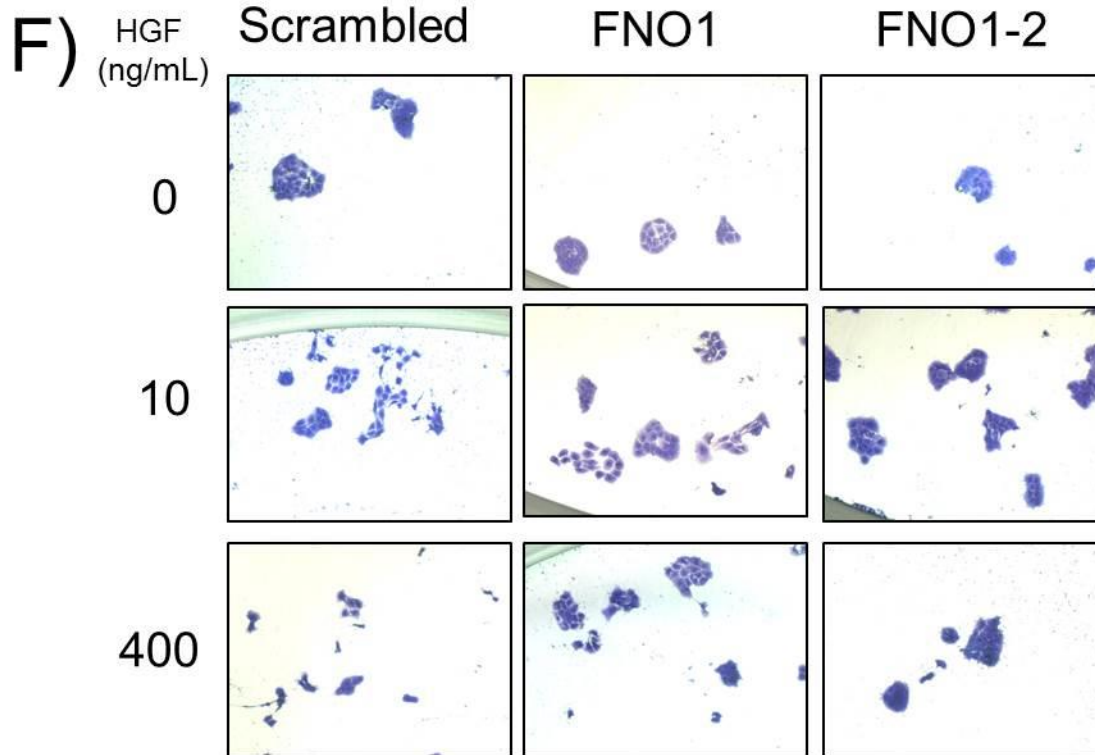

Figure 28. Continued. D) A431 cells transfected with FNO1 and FNO1-2 show decreased cell invasion with HGF treatment compared to the scrambled control and 12(S)-HETE does not rescue the reduced invasion. Cells were transfected with peptides using Chariot for four hours before treatment with the indicated reagents. Cells were allowed to invade through a Boyden chamber coated with Matrigel for 18 hours. 0.25% lipid stripped FBS and 10% FBS were run as negative and positive controls respectively. Invasion was quantified by measuring the absorbance at 570nm of the crystal violet stain extracted from invaded cells. * $p < 0.05$, student's T-test, bars represent the average of three trials. E) β -galactosidase positive control for invasion assay. F) Replication of scatter assay from part A using FNO1 or FNO1-2 transfected cell lines after 4 days of colony formation instead of 7. G) Quantitation of intact/HGF-non-responsive colonies for part F, counted in triplicate +/- SEM. H) β -galactosidase staining used to monitor transfection efficiency of for part F scatter assay.



Summary

Altogether, the results above suggest the following: under serum-starved or basal (non-serum-starved) conditions, $\beta 4$ and c-Met associate while $\beta 4$ is incorporated into hemidesmosome-like structures. HGF stimulation caused disruption of the $\beta 4$ /c-Met complex, a decrease in hemidesmosome-like structures, $\beta 4$ phosphorylation on tyrosine residues, and 12-LOX recruitment to the integrin. Despite 12-LOX association with $\beta 4$, HGF did not stimulate 12-LOX production of 12(S)-HETE, but rather 12-LOX regulated $\beta 4$ cross-activation by the c-Met receptor. 12-LOX knockdown reduced HGF-induced $\beta 4$ phosphorylation and decreased downstream signaling to AKT and ERK thereby functionally affecting HGF-driven cell scattering and invasion. 12-LOX KD resulted in decreased cell scattering and invasion with HGF treatment compared to the ns shRNA controls cell. Similarly, cell transfection with FNO1 or FNO1-2, to inhibit $\beta 4$ interaction with 12-LOX, also led to decreased cell scattering and invasion compared to the scrambled control. Therefore, a novel function has been described for 12-LOX where the enzyme, together with $\beta 4$, enhances c-Met mediated cancer cell motility and invasion through a scaffolding function.

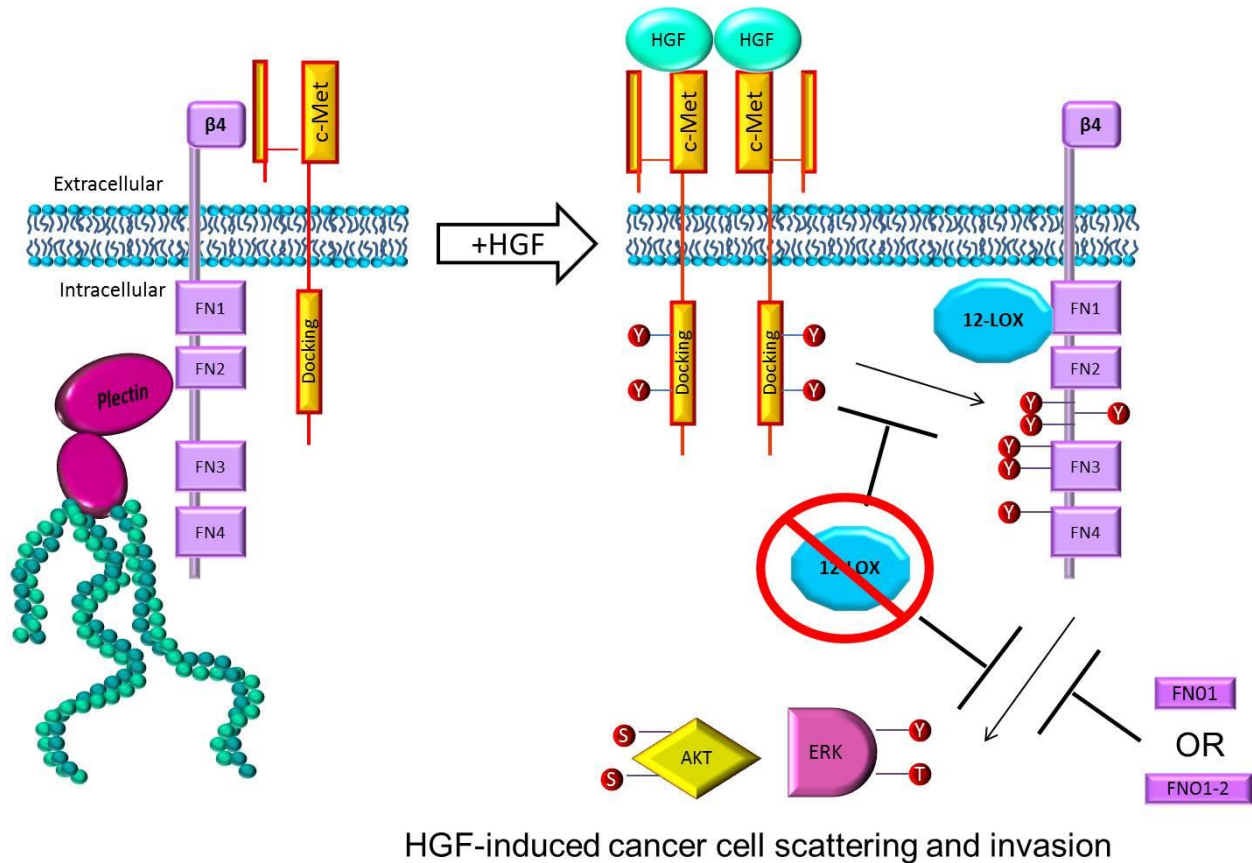

Figure 29. 12-LOX Acts as a Scaffold to Enhance c-Met-mediated Cell Scattering and Invasion.

Under serum-starved or basal (non-serum-starved) conditions, $\beta 4$ and c-Met associate while $\beta 4$ is incorporated into hemidesmosome-like structures. With HGF stimulation, the $\beta 4$ /c-Met complex was disrupted, hemidesmosome-like structures were decreased in number, $\beta 4$ was phosphorylated on tyrosine residues, and 12-LOX was recruited to the integrin. Despite 12-LOX association with $\beta 4$, the enzyme was not activated to produce 12(S)-HETE, but rather regulated $\beta 4$ cross-activation by the c-Met receptor following HGF stimulation. Knockdown of 12-LOX reduced HGF-induced $\beta 4$ phosphorylation and decreased downstream signaling to AKT and ERK, which functionally affected HGF-driven cell scattering and invasion. Cell transfection with FNO1 or FNO1-2 peptides, which inhibited $\beta 4$ interaction with 12-LOX, also led to decreased $\beta 4$ activation and downstream signaling following HGF stimulation resulting in decreased cell scattering and invasion compared to the scrambled control. Therefore, 12-LOX cooperates with $\beta 4$ to enhance c-Met mediated cancer cell motility and invasion through a novel scaffolding function.

Prostate Cancer Cell Line Results

β 4 interacts with c-Met in a constitutive manner in prostate cancer cells

As mentioned earlier, β 4 and c-Met interaction in cancer cells is controversial, as there is literature to suggest the two interact and cooperate to enhance c-Met tumorigenic signaling through the SRC-SHP2 axis (Bertotti et al. 2005; Bertotti et al. 2006; Trusolino et al. 2001; Yoshioka et al. 2013). However, there is also literature arguing β 4 is not necessary for c-Met-induced signaling and that the receptor can function independently of β 4 to promote tumor cell invasion and metastasis (Chung et al. 2004; Merdek et al. 2007). Carcinoma cells that lack β 4 expression still respond to HGF-induced c-Met-mediated invasion (Chung et al. 2004), clearly indicating that β 4 is not *required* for c-Met mediated invasive signaling. In prostate cancer cells, β 4 may, like in the A431 epidermoid carcinoma cells, play an important role in promoting c-Met-mediated cell scattering and invasion in the context of 12-LOX. To determine whether or not β 4 and c-Met interact in prostate cancer cells, we carried out co-immunoprecipitation studies in PC-3M prostate cancer cells. These cells natively express c-Met, β 4, and 12-LOX (Figure 15A). After immunoprecipitation for β 4, c-Met associated with the integrin in a constitutive manner, as there was no difference between serum-starved, non-serum-starved (basal), or HGF-treated conditions (Figure 30A). Because HGF stimulation of the c-Met receptor did not affect its interaction with β 4, we wanted to determine if stimulation of β 4 using 3E1 would modify the complex. Despite 3E1 treatment, the same amount of c-Met was pulled-down compared to serum-starved, basal, or HGF conditions. As a positive control, c-Met was pulled down in serum-starved cells and run next to the β 4 immunoprecipitated samples, and as a negative control, mouse IgG was immunoprecipitated to detect any non-specific interactions. The blot was re-probed for β 4 to ensure equal pull-down across samples, as was done for every following immunoprecipitation experiment. There appeared to be less total β 4 in the 3E1 treated sample, and this was due to

treatment of the cells with the $\beta 4$ activating antibody followed by pre-clearing during the immunoprecipitation protocol. When c-Met was pulled down in the reciprocal immunoprecipitation experiment, 3E1 stimulation lead to significantly greater levels of $\beta 4$ recruited to the receptor (Figure 30B). However, laminin stimulation of $\beta 4$ did not result in enhanced integrin interaction with c-Met (Figure 30C), indicating that $\beta 4$ stimulation does not affect its association with c-Met. Constitutive interaction of c-Met with $\beta 4$ was also shown in PC-3, PC-3 12-LOX overexpressing, and PC-3 3.1 control cells (Figure 31A-C). The interaction was recently detected in DU145 prostate cancer cells (Yoshioka et al. 2013), although we could not replicate the interaction in that cell line. Both $\beta 4$ and c-Met are known to recycle from the membrane after activation. However, fractionation revealed both remain localized to the membrane after 30 minute treatments with either 3E1 or HGF, suggesting that is where the proteins are interacting (Figure 31D).

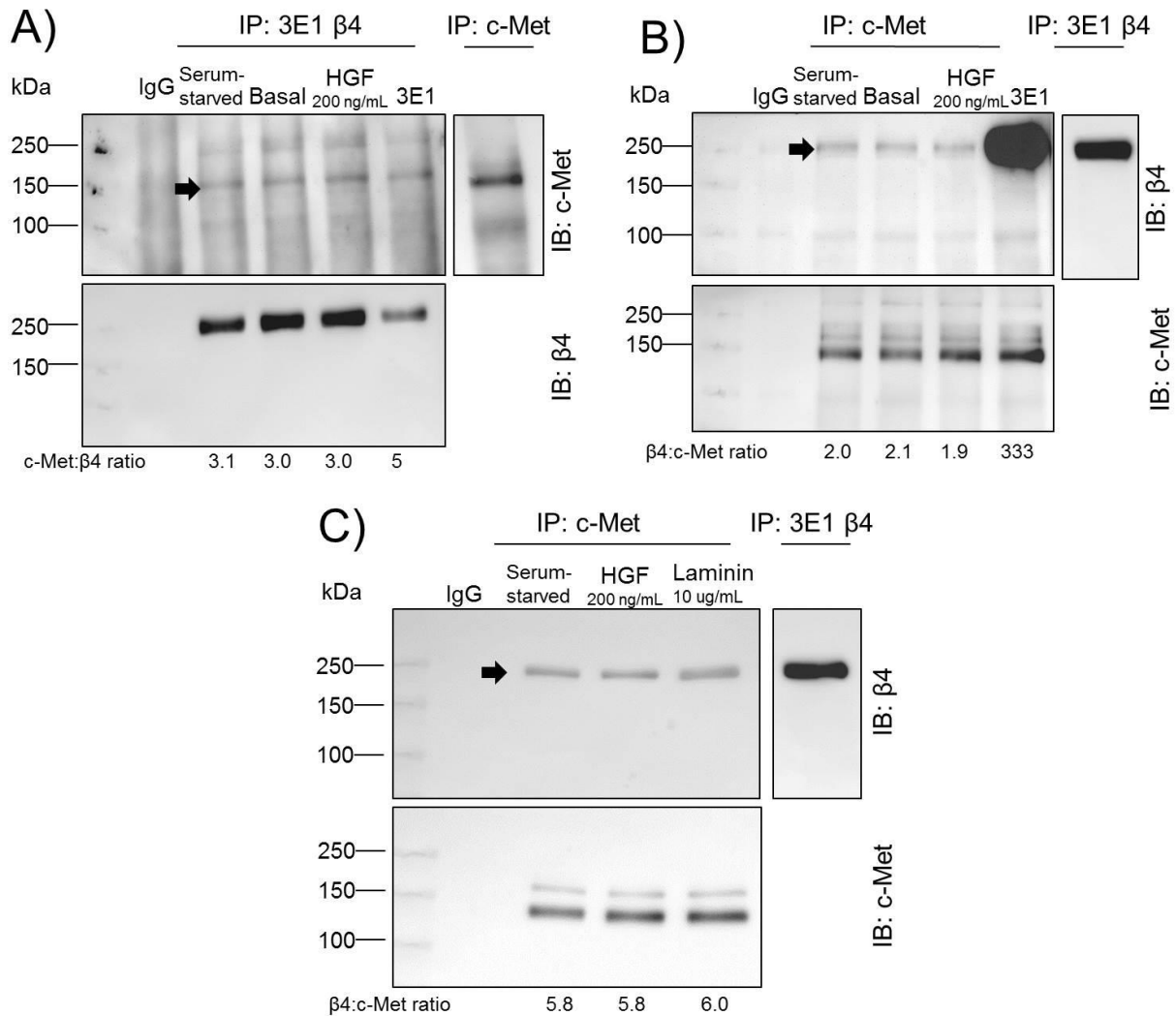

Figure 30. HGF Stimulation Does Not Disrupt β 4 and c-Met Association in PC-3M Prostate Cancer Cells. β 4 and c-Met associate constitutively in PC-3M prostate cancer cells, regardless of c-Met or β 4 activation. Cells were treated with HGF (200 ng/mL), 3E1 or laminin (10 μ g/mL) for 30 minutes. In immunoprecipitates, densitometry represents the ratio of co-immunoprecipitated (upper panel) to pulled-down (lower panel) protein. Matched IgG was immunoprecipitated as a control. For positive controls, direct immunoprecipitation of the co-immunoprecipitated protein was performed (last lane; upper panel). The blots were probed with the indicated antibodies, then stripped and re-probed for the immunoprecipitated protein (lower panel) to ensure equal pull-down. A) Immunoprecipitation of β 4 (using 3E1 antibodies) in PC-3M cells followed by Western blot analysis for c-Met. B) Immunoprecipitation of c-Met in PC-3M cells followed by Western blot analysis for β 4. C) Immunoprecipitation of c-Met in PC-3M cells treated with laminin instead of 3E1 followed by Western blot analysis for β 4.

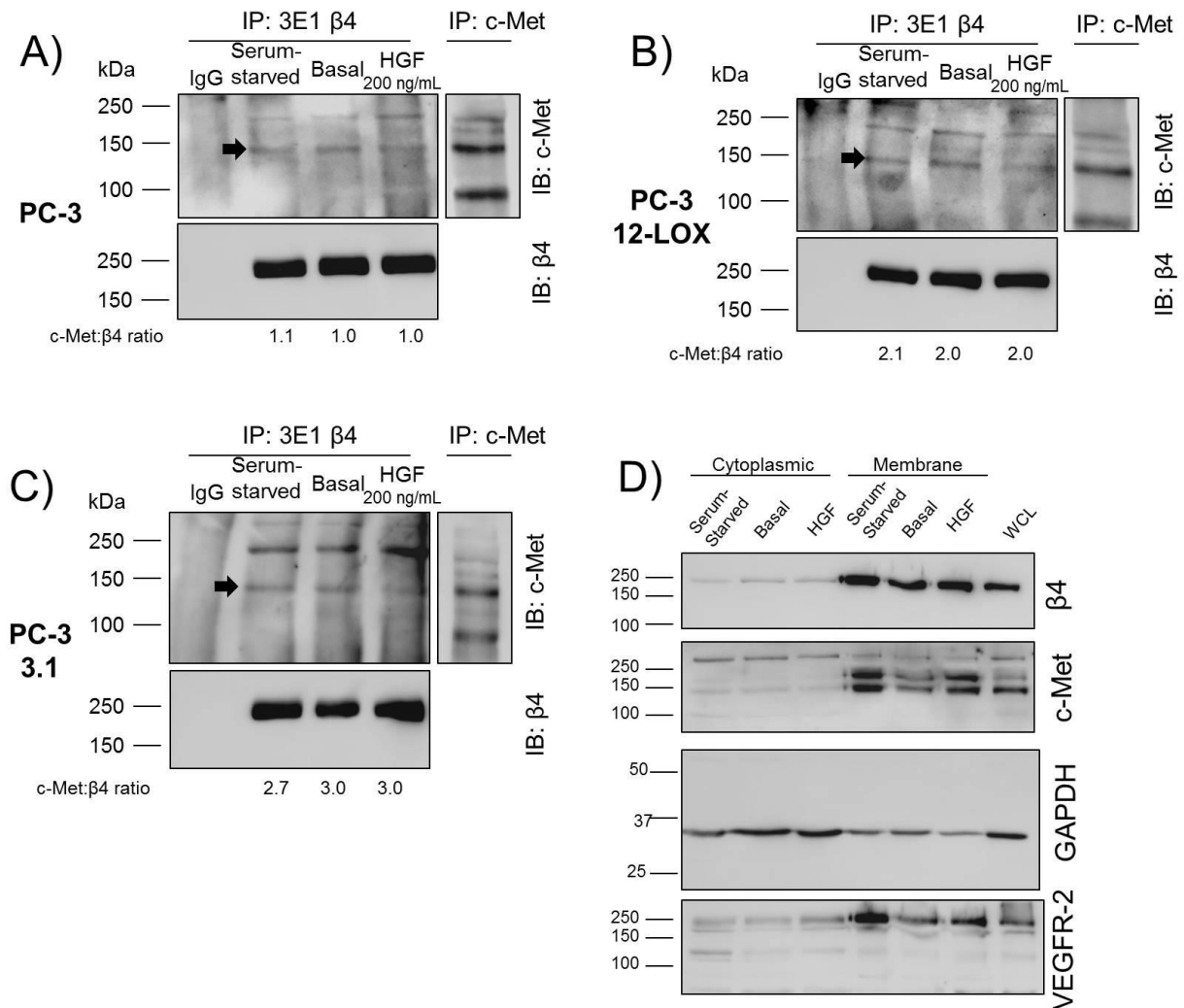
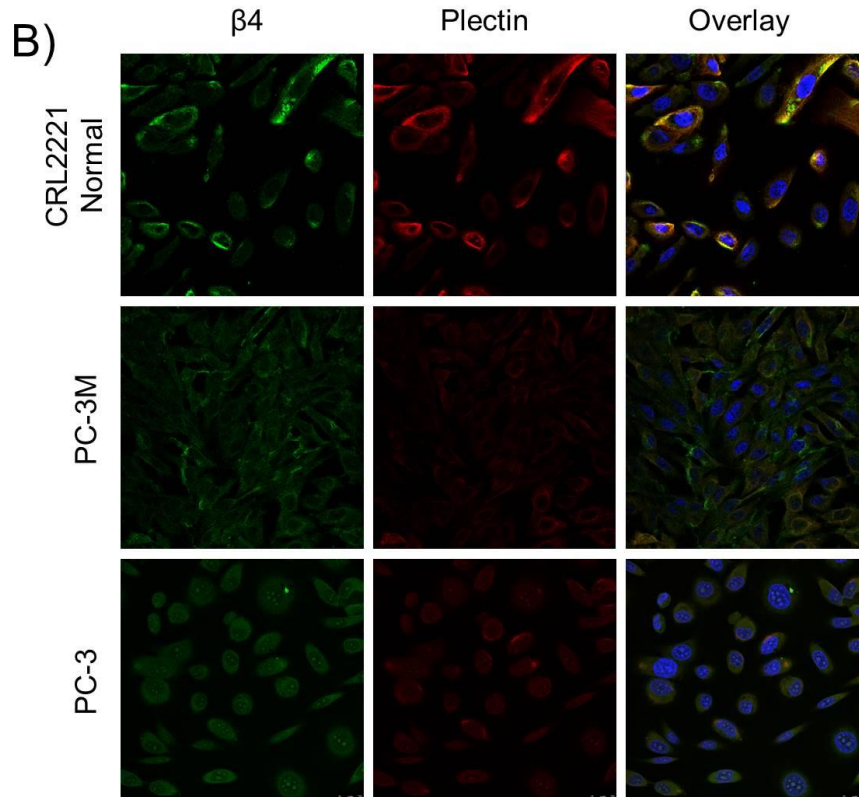
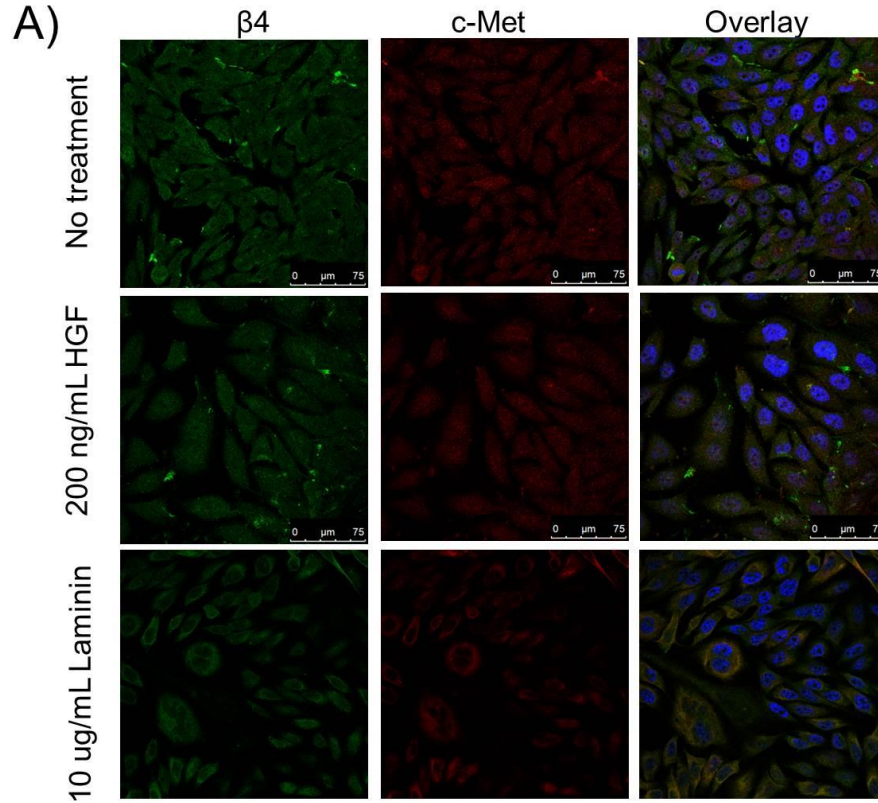

Figure 31. HGF Stimulation Does Not Disrupt β4 and c-Met Association in PC-3, PC-3 12-LOX Overexpressing, or PC-3 Empty Vector Prostate Cancer Cells. β4 and c-Met associate constitutively in prostate cancer cells, regardless of c-Met or β4 activation. Cells were treated with HGF (200 ng/mL) or 3E1 for 30 minutes. In immunoprecipitates, densitometry represents the ratio of co-immunoprecipitated (upper panel) to pulled-down (lower panel) protein. Matched IgG was immunoprecipitated as a control. For positive controls, direct immunoprecipitation of the co-immunoprecipitated protein was performed (last lane; upper panel). The blots were probed with the indicated antibodies, then stripped and re-probed for the immunoprecipitated protein (lower panel) to ensure equal pull-down. Immunoprecipitation of β4 (using 3E1 antibodies) in A) parental PC-3, B) PC-3 cells transfected with a 12-LOX expression construct and C) PC-3 empty vector controls followed by Western blot analysis for c-Met. D) After 30 minutes HGF treatment, both β4 and c-Met remain localized to the membrane. Fractionation of PC-3M whole cell lysate followed by Western blot analysis with the indicated antibodies. The blot was probed for GAPDH as a control for the cytoplasmic fraction and for VEGFR-2 as a control for the membrane fraction.

To corroborate the immunoprecipitation data, immunofluorescence studies were performed to detect the c-Met and $\beta 4$ interaction. As was seen in the immunoprecipitation data, neither $\beta 4$ nor c-Met activation via their cognate ligands affected the co-localization in PC-3M cells (Figure 32A). In A431 cells we showed that $\beta 4$ and c-Met interaction is disrupted by HGF stimulation and was due to the disruption of hemidesmosome-like structures (Figure 16). A431 cells are known to form hemidesmosomes (Rabinovitz et al. 1999). However, prostatic carcinoma tissue samples reveal an absence of hemidesmosomes (Nagle et al. 1995). As mentioned previously, the simplest hemidesmosome, type II, is marked by plectin co-localization with $\beta 4$. Both the diffuse $\beta 4$ staining pattern and lack of co-localization of $\beta 4$ with plectin in PC-3 and PC-3M cells indicate that these cells do not form hemidesmosomes compared to the control (CRL-2221 normal immortalized prostate cells) (Figure 32B). Secondary antibody controls show no non-specific interaction (Figure 32C).



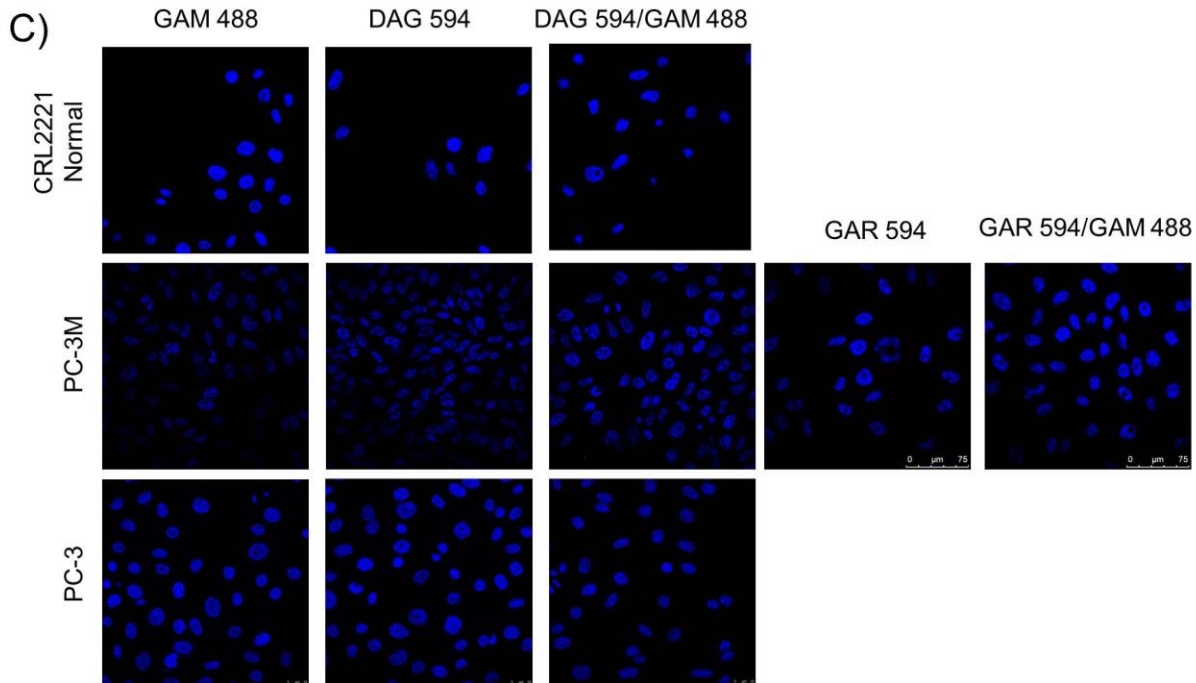

Figure 32. Confocal Immunofluorescence Confirms HGF Does Not Affect β 4 and c-Met Co-localization in PC-3M Prostate Cancer Cells and that Prostate Cancer Cells Do Not Form Hemidesmosomes. A) Confocal immunofluorescence confirming that β 4 and c-Met co-localization in PC-3M cells is not affected by 30 minutes HGF (200 ng/mL) or laminin (10 μ g/mL) stimulation. Cells were plated on Matrigel coated glass coverslips and serum-starved overnight before treatment. Co-localization of β 4 (Alexa Fluor GAM488, green) with c-Met (Alexa Fluor DAR594, red) are shown as single stains and in the merged overly images for each condition. B) Confocal immunofluorescence in CRL2221 normal immortalized prostate cells, PC-3M, and PC-3 cells confirm prostate cancer cells do not form hemidesmosomes. Cells were seeded onto Matrigel coated glass coverslips. β 4 (green) and plectin (DAG594, red) co-localization indicates a type II hemidesmosome. C) Secondary antibody controls.

β4 is activated by c-Met, resulting in 12-LOX recruitment in prostate cancer cells

We have already shown that β4 can be phosphorylated by the c-Met receptor following its activation by HGF in A431 cells (Figures 17&18). Next, we asked whether or not this occurs in PC-3M prostate cancer cells. Immunoprecipitation of β4 following HGF stimulation did reveal that a 150 kDa protein was tyrosine phosphorylated (Figure 33A). This result was puzzling given the fact that full-length β4 is 204 kDa and runs just under 250 kDa on a 10% SDS-PAGE gel as detected by CD104, an antibody that recognizes the cytoplasmic tail of β4 (Figure 33B). Re-probing of the blot with clone 439-9B, another antibody to β4, that like 3E1 is directed toward an extracellular epitope, recognized both the smaller secondary band running at 150 kDa in addition to full-length β4 (Figure 33A; lower panel). This suggests that 3E1 may be pulling down both full length and a cleaved form of β4. Immunoprecipitation using the β4 specific antibody CD104, instead of 3E1, resulted in HGF-induced β4 phosphorylation with band patterning corresponding to full-length β4 (Figure 33C). Indeed, there are several calpain cleavage sites found along the cytoplasmic tail of β4, resulting in approximately 165 kDa and 130 kDa sized fragments (Giancotti et al. 1992) (Figure 33B). Because these cleavage sites are found on the tail of β4, it is possible that immunoprecipitation using 3E1 could pull-down a cleaved form of β4 whereas immunoprecipitation with CD104 would pull-down only full-length β4 that has not yet been cleaved. In fact, detection of β4 in PCa tissue samples using several antibodies targeted to β4 suggest that cleaved forms of β4 exist in cells *in vivo* (Davis et al. 2001). In conclusion, β4 was phosphorylated in PC-3M cells following HGF stimulation.

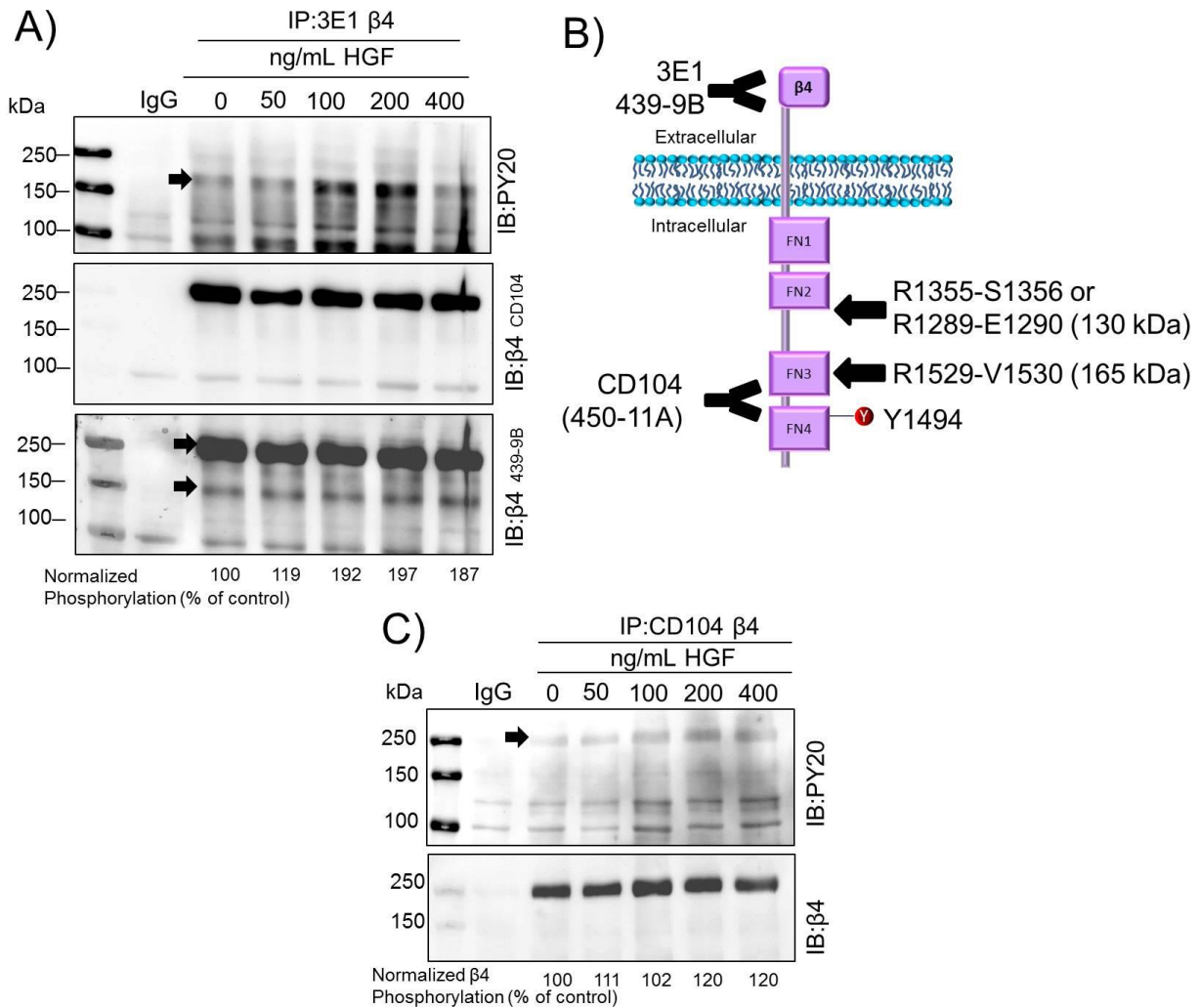

Figure 33. HGF Stimulation Results in β 4 Phosphorylation in PC-3M Prostate Cancer Cells.

HGF stimulation (30 minutes; indicated concentrations) results in tyrosine phosphorylation of a 150 kDa protein and full-length β 4 in PC-3M cells. In immunoprecipitates, densitometry represents the ratio of phosphorylated protein (upper panel) to pulled-down protein (lower panel), normalized to the non-treated control. Matched IgG was immunoprecipitated as a control. The blots were probed with the indicated antibodies (upper panel), then stripped and re-probed for the immunoprecipitated protein (lower panel) to ensure equal pull-down and to calculate densitometry. A) Immunoprecipitation of β 4 (using 3E1 antibodies) followed by Western blot analysis with PY20. The membrane was stripped and re-probed for β 4 using both CD104 (middle panel) and 439-9B (lower panel) antibodies. B) Schematic of antibody targeted epitopes within β 4 and the location of two known calpain cleavage sites. C) Immunoprecipitation of β 4 (using CD104 antibodies) followed by Western blot analysis with PY20.

After confirming that HGF induces $\beta 4$ activation in PC-3M cells, phosphorylation of $\beta 4$ -Y1494 was then tested for activation with HGF. To reiterate, this residue is hypothesized to be a master regulator of $\beta 4$ function (Dutta & Shaw 2008) and is phosphorylated following HGF stimulation in A431 cells (Figure 17). Immunoprecipitation for $\beta 4$ using either CD104 (Figure 34A) or 3E1 (Figure 34B) following treatment with increasing concentrations of HGF revealed that $\beta 4$ -Y1494 is not phosphorylated in PC-3M cells compared to A431 positive controls. 3E1 stimulation also did not result in $\beta 4$ -Y1494 phosphorylation in this cell line (Figure 34B). Downstream signaling of $\beta 4$ -Y1494 involves AKT activation (Shaw 2001) and even though $\beta 4$ -Y1494 was not phosphorylated with HGF, robust AKT activation still occurred (Figure 34C). This suggests the prostate cancer cells have found an alternate mechanism to mediate $\beta 4$ enhancement of c-Met downstream signaling through AKT independent of $\beta 4$ -Y1494. Additionally, there may be other $\beta 4$ specific residues other than $\beta 4$ -Y1494 that are important for c-Met signaling in prostate cancer cells. These results show that HGF induces $\beta 4$ phosphorylation and downstream signaling, without $\beta 4$ -Y1494 phosphorylation, in PC-3M cells.

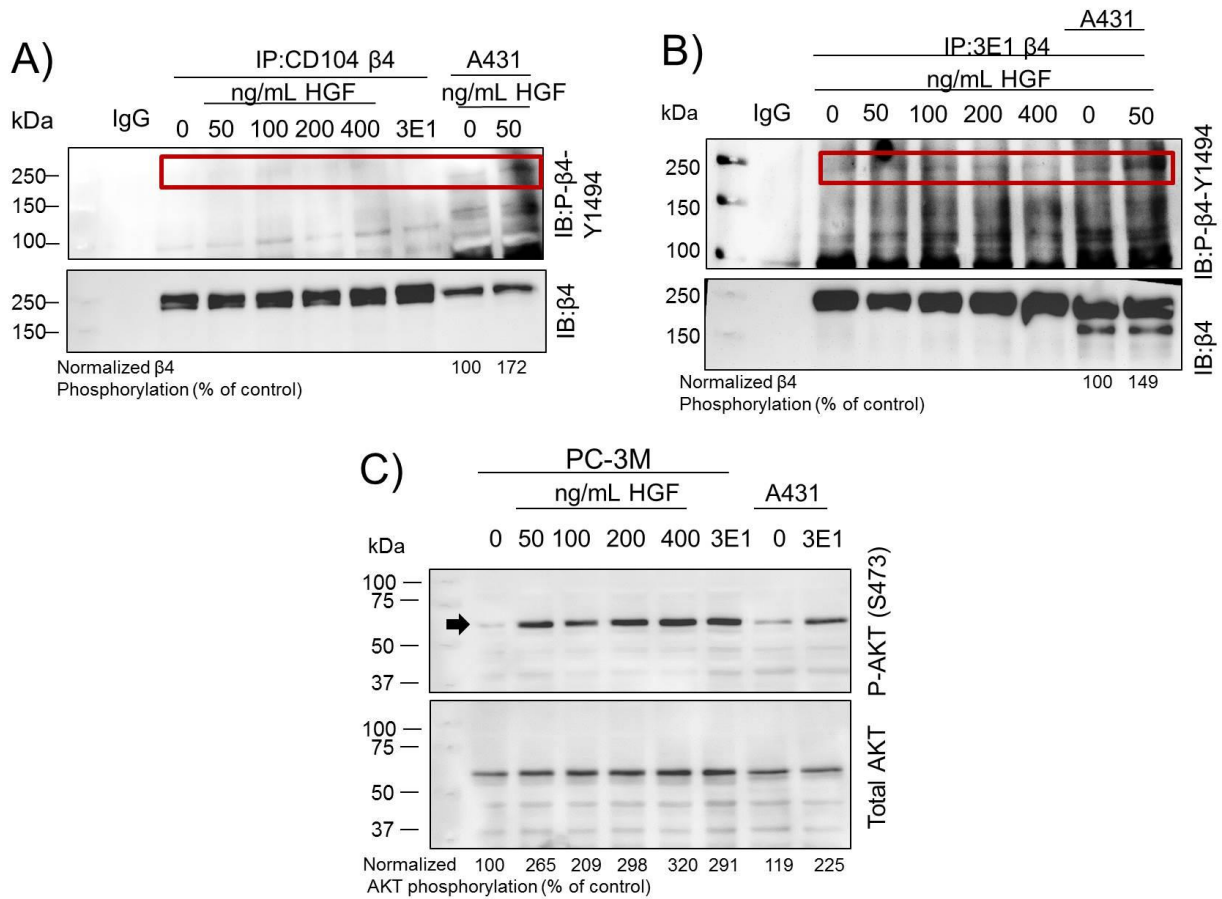

Figure 34. HGF Stimulation Does Not Result in β 4-Y1494 Phosphorylation in PC-3M Prostate Cancer Cells. HGF stimulation (30 minutes; indicated concentrations) does not result in β 4-Y1494 phosphorylation. In immunoprecipitates, densitometry represents the ratio of phosphorylated protein (upper panel) to pulled-down protein (lower panel), normalized to the non-treated control. Matched IgG was immunoprecipitated as a control. The blots were probed with the indicated antibodies (upper panel), then stripped and re-probed for the immunoprecipitated protein (lower panel) to ensure equal pull-down. A) Immunoprecipitation of β 4 (using CD104 antibodies) followed by Western blot analysis with phospho-specific β 4-Y1494. A431 cells treated with HGF were used as a positive control for β 4-Y1494 phosphorylation. B) Immunoprecipitation of β 4 (using 3E1 antibodies) followed by Western blot analysis with phospho-specific β 4-Y1494. A431 cells treated with HGF were used as a control. C) HGF stimulation (30 minutes; indicated concentrations) results in AKT activation comparable to 3E1 stimulation. Western blot analysis of PC-3M whole cell lysates probed for phosphorylated AKT (upper panel). The membrane was stripped and re-probed for total AKT (lower panel). A431 cells treated with 3E1 were used as a positive control. Densitometry represents the ratio of phosphorylated AKT to total AKT.

Given that $\beta 4$ is activated after HGF treatment in PC-3M cells and that downstream signaling to AKT still occurs despite the lack of $\beta 4$ -Y1494 phosphorylation, we wanted to determine whether this results in 12-LOX recruitment to the integrin. Immunoprecipitation for $\beta 4$ revealed low levels of 12-LOX interacting with the integrin when cells were treated with HGF or 3E1 (Figure 35A). Human platelets express high levels of 12-LOX, therefore platelet lysate was loaded as a running control but exposed separately due to the band intensity. We also immunoprecipitated c-Met to test for 12-LOX interaction as we have shown that $\beta 4$ and c-Met constitutively associate in PC-3M cells. Pull-down for c-Met again showed weak interaction of 12-LOX with the receptor in cells treated with HGF or 3E1 (Figure 35B). The low levels of 12-LOX interaction with $\beta 4$ and c-Met could be the result of low 12-LOX protein expression in PC-3M cells (Figure 15). To address this issue, PC-3M cells stably transfected with a 12-LOX expression construct were used to immunoprecipitate $\beta 4$. Additionally, 4 mg of protein was used for the immunoprecipitation to ensure efficient recovery of both 12-LOX and c-Met from the cell lysate. In the PC-3M 12-LOX transfectants, HGF stimulation caused 12-LOX recruitment to $\beta 4$, similar to the 3E1 control (Figure 35C; upper panel). A longer exposure of the blot revealed low levels of 12-LOX interacting with $\beta 4$ in the PC-3M empty vector controls, like that seen in the PC-3M parental cells (Figure 35A). HGF stimulation also decreased c-Met interaction with $\beta 4$ in the PC-3M 12-LOX overexpressors compared to controls (Figure 35C; middle panel). This suggests that, when abundantly expressed, 12-LOX may be influencing $\beta 4$ and c-Met interaction in PC-3M cells. These results agree with those seen in A431 cells, where these cells express high levels of 12-LOX and $\beta 4$ and c-Met interaction is disrupted with HGF stimulation (Figure 15). Recruitment of 12-LOX to $\beta 4$ with HGF stimulation indicates the enzyme may play a role in HGF mediated functions, such as migration or invasion, as we have also shown in A431 cells (Figures 25 & 28).

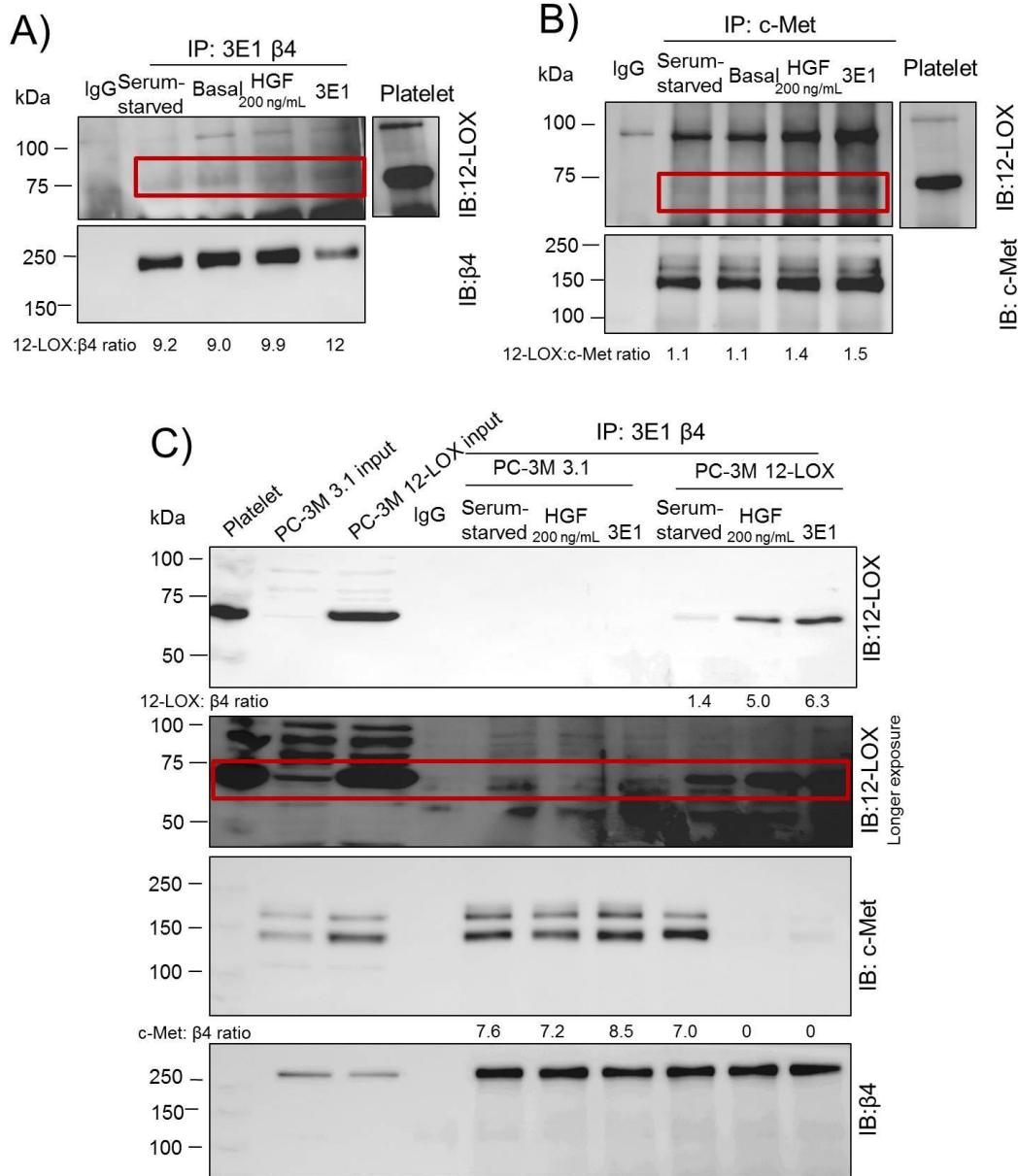

Figure 35. HGF Stimulation Leads to 12-LOX Recruitment to β 4 in PC-3M Prostate Cancer Cells. A-C: 12-LOX interacts with β 4/c-Met with HGF stimulation (30 minutes) compared to 3E1 treatment. In immunoprecipitates, densitometry represents the ratio of co-immunoprecipitated 12-LOX (upper panel) to pulled-down (lower panel) protein. Matched IgG was immunoprecipitated as a control. Human platelet lysate was run as a positive control for 12-LOX. The blots were probed with anti-12-LOX antibody, then stripped and re-probed for the immunoprecipitated protein (lower panel) to ensure equal pull-down. A) Immunoprecipitation of β 4 (using 3E1 antibodies) in PC-3M cells followed by Western blot analysis for 12-LOX. B) Immunoprecipitation of c-Met in PC-3M cells followed by Western blot analysis for 12-LOX. C) Immunoprecipitation of β 4 (using 3E1 antibodies; 4 mg protein) in PC-3M 12-LOX stable transfectants and empty vector controls followed by Western blot analysis for 12-LOX. The membrane was stripped and re-probed for c-Met (middle panel) and β 4 (lower panel).

12-LOX inhibition reduces HGF-induced invasion in prostate cancer cells

Next, because HGF stimulation caused recruitment of 12-LOX to β_4 , we wanted to test whether 12-LOX was involved in HGF-induced invasion. First, the optimal HGF concentration required to stimulate PC-3M invasion through transwell inserts coated with Matrigel was determined to be 400 ng/mL (Figure 36A). Following pre-treatment with either of two 12-LOX specific inhibitors, BMD122 or baicalein, HGF-stimulated cellular invasion was found to decrease significantly compared to HGF treatment alone (Figure 36B&C). As mentioned previously, BMD122 inhibits 12-LOX enzymatic activity by chelating the iron at its core. Baicalein inhibits lipid peroxidation. If 12-LOX enzymatic activity is important for invasion, i.e. inhibition of 12-LOX activity and subsequent reduction of 12(S)-HETE levels was leading to decreased invasion, then 12(S)-HETE added back should rescue the phenotype. Interestingly, 12(S)-HETE addition did not rescue the reduced invasion in PC-3M (Figure 36D) or DU145 (Figure 37A) cells. DU145 prostate cancer cells express higher levels of endogenous 12-LOX than PC-3 cells and have been shown to invade after HGF stimulation while PC-3 cells do not (Humphrey et al. 1995). Again, inhibition of 12-LOX enzymatic activity by BMD122 (Figure 37A) and baicalein (Figure 37B), reduced HGF-induced invasion in DU145 cells and 12(S)-HETE did not rescue the reduced invasion. Several concentrations of 12(S)-HETE were utilized because 12(S)-HETE activation of 12HETER-1 manifests in a bell shaped curve where the optimal concentrations range from 100-600 nM (Guo et al. 2011b).

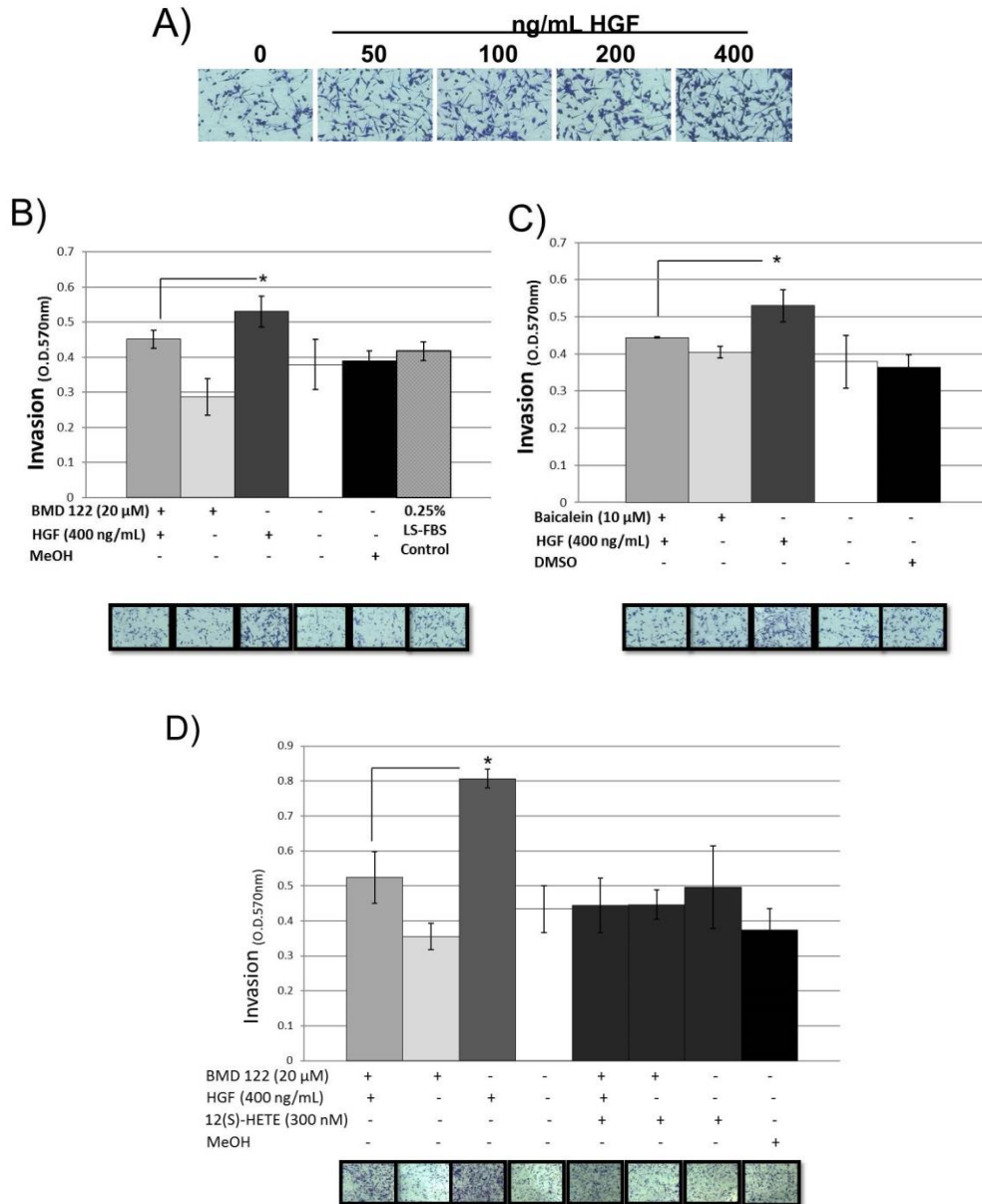

Figure 36. Inhibition of 12-LOX Enzymatic Activity Reduces HGF-induced Invasion and is Not Rescued by 12(S)-HETE in PC3-M Prostate Cancer Cells. Boyden chamber invasion assays indicate BMD122 and baicalein reduce HGF-induced invasion and the effect is not rescued by 12(S)-HETE. Where indicated, cells were pre-treated with 20 μ M BMD122 or 10 μ M baicalein for two hours before HGF or 12(S)-HETE stimulation at indicated concentrations, then cells were allowed to invade through Matrigel coated inserts for 8 hours. MeOH and DMSO were used as vehicle controls for BMD122 and baicalein respectively. 0.25% FBS was used as a negative control. Invasion was quantified by measuring the absorbance at OD_{570nm} of the crystal violet stain extracted from invaded cells. * $p < 0.05$, student's T-test, bars represent the average of three trials. A) Optimization of HGF concentrations for invasion. B) BMD122 and C) baicalein inhibition of 12-LOX enzymatic activity reduces HGF-induced invasion in PC-3M cells. D) 12(S)-HETE (300 nM) does not rescue BMD122 inhibited, HGF-induced invasion.

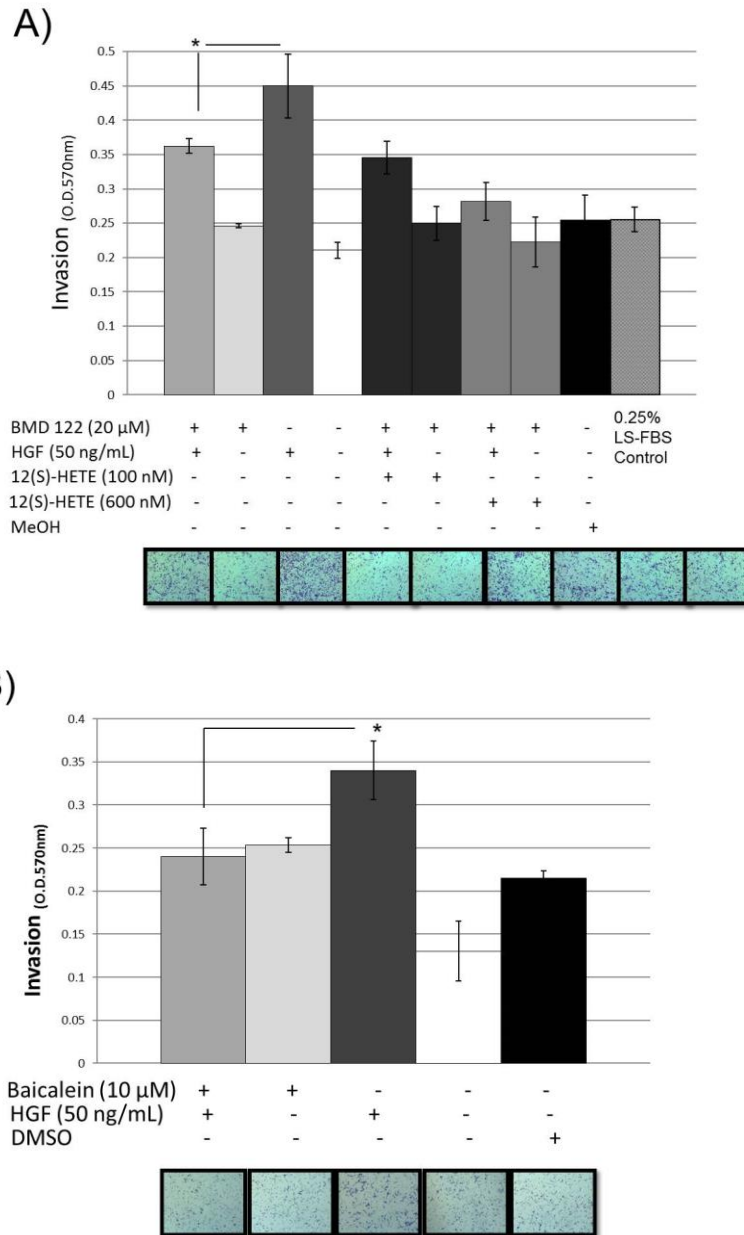

Figure 37. Inhibition of 12-LOX Enzymatic Activity Reduces HGF-induced Invasion and is Not Rescued by 12(S)-HETE in DU145 Prostate Cancer Cells. Boyden chamber invasion assays indicate BMD122 and baicalein reduce HGF-induced invasion and the effect is not rescued by 12(S)-HETE. Where indicated, cells were pre-treated with 20 μ M BMD122 or 10 μ M baicalein for two hours before HGF or 12(S)-HETE stimulation at indicated concentrations, then cells were allowed to invade through Matrigel coated inserts for 24 hours. MeOH and DMSO were used as vehicle controls for BMD122 and baicalein respectively. 0.25% FBS was used as a negative control. Invasion was quantified by measuring the absorbance at OD_{570nm} of the crystal violet stain extracted from invaded cells. * $p < 0.05$, student's T-test, bars represent the average of three trials. A) BMD122 and B) baicalein inhibition of 12-LOX enzymatic activity reduces HGF-induced invasion in DU145 cells. 12(S)-HETE (100 and 600 nM) does not rescue BMD122-inhibited, HGF-induced invasion.

After being metabolized by 12-LOX, 12(S)-HETE acts to stimulate its own receptor 12HETER-1 (Guo et al. 2011b). Our lab recently discovered that β 4 interacts with the 12(S)-HETE receptor (Honn, unpublished data). To rule out the possibility that 12HETER-1 may also be involved in HGF-induced invasion, PC-3M cells stably expressing plasmid DNA encoding shRNA to knockdown the receptor were subjected to the same Boyden chamber invasion assay as the wild-type PC-3M cells above. HGF robustly induced cellular invasion that was significantly reduced by BMD122 inhibition of 12-LOX in 12HETER-1 silenced cells and non-silencing control cells (Figure 38A&B). As seen in the wild type parental cells, the addition of 12(S)-HETE does not rescue the reduced invasion in the 12HETER-1 silenced cells. As a control, we confirmed 12HETER-1 mRNA (Figure 38C) and protein expression (Figure 25D) in prostate cancer cells relative to the cell line that 12HETER-1 was cloned out of, PC-3. Additionally, we verified with Western blot that 12(S)-HETE leads to downstream activation of ERK in DU145 and PC-3M prostate cancer cells (Figure 38D&E).

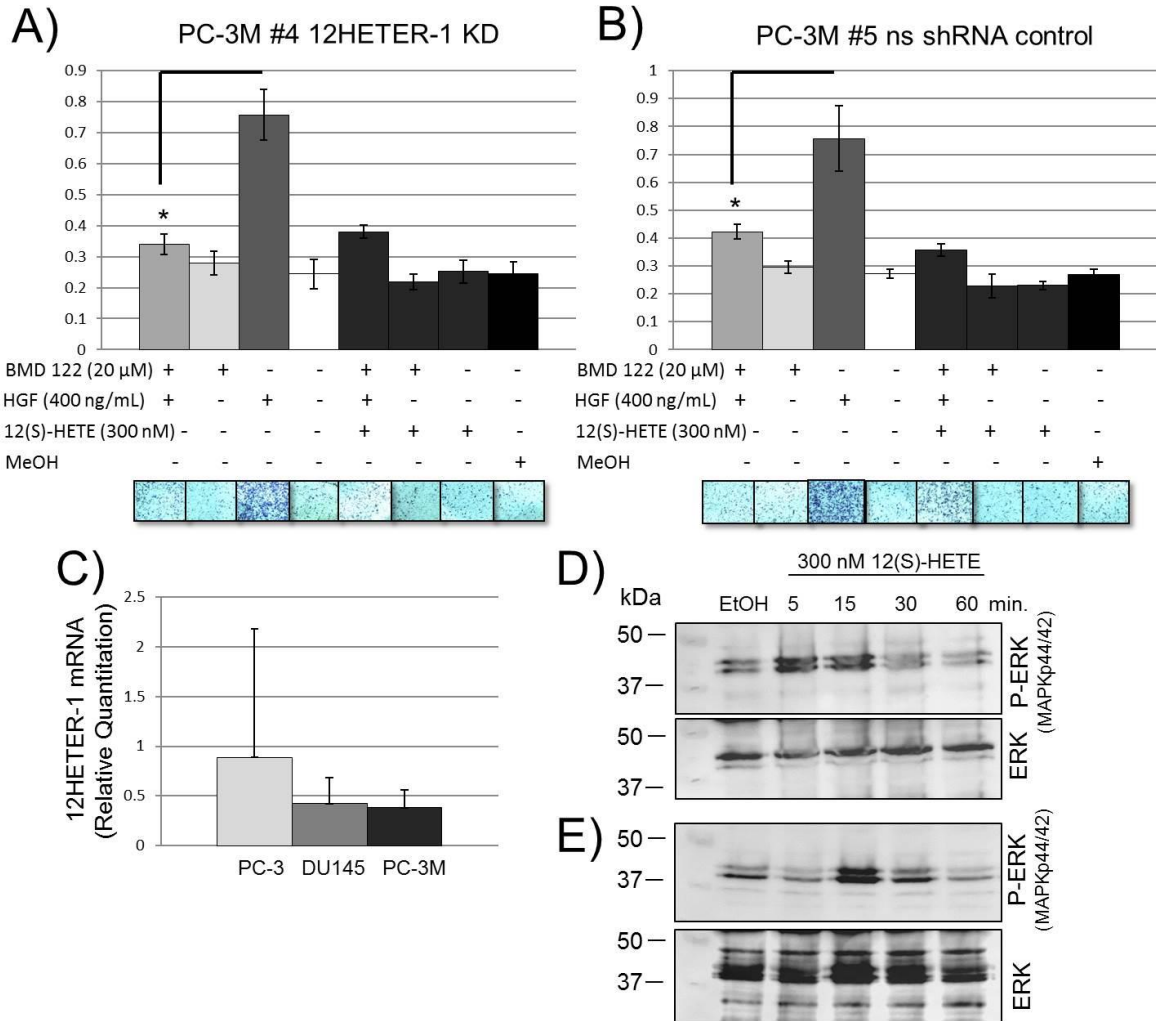

Figure 38. 12HETER-1 Does Not Play a Role in HGF-induced Invasion in PC-3M Prostate Cancer Cells. A&B: Boyden chamber invasion assay of PC-3M cells stably transfected with siRNA, to silence 12HETER-1 expression, plus non-silencing (ns) controls. Where indicated, cells were pre-treated with 20 μ M BMD122 for two hours before HGF stimulation with indicated concentrations. 12(S)-HETE (300 nm) was added at the same time as HGF. MeOH was used as a vehicle control for BMD122. Invasion was quantified by measuring the absorbance at OD_{570nm} of the crystal violet stain extracted from invaded cells. * $p < 0.05$, student's T-test, bars represent the average of three trials. A) PC-3M 12HETER-1 KD and B) ns control cells were treated with the indicated reagents and allowed to invade through a Matrigel coated Boyden chamber for 8 hours. C) RT-PCR indicates prostate cancer cells express 12HETER-1. DU145 and PC-3M cells were analyzed for 12HETER-1 expression. PC-3 cells were used as a control. D&E: Signaling downstream of 12HETER-1 occurs in prostate cancer cells. D) DU145 and E) PC-3M cells were treated with 300 nm 12(S)-HETE for the indicated times and ERK phosphorylation was detected by Western blot analysis. The membranes were stripped and re-probed for total ERK (lower panel).

To ensure the reduction in HGF-induced invasion was not due to BMD122 disruption of $\beta 4$ and c-Met interaction, PC-3M cells were immunoprecipitated for $\beta 4$ following BMD122 and HGF stimulation. BMD122 pre-treatment did not affect $\beta 4$ and c-Met interaction in serum-starved, basal, or HGF treated cells (Figure 39A). We also checked to see if BMD122 was causing a reduction in c-Met phosphorylation, which might explain the decrease in HGF-induced invasion. BMD122 pre-treatment also did not inhibit or reduce c-Met phosphorylation as detected by PY20 (Figure 39B). Additionally, stimulation of $\beta 4$ with 3E1 did not result in cross-activation of c-Met. These results indicate that enzymatic inhibition of 12-LOX reduces HGF-induced invasion, which is not rescued by exogenous 12(S)-HETE addition, but that this is not due to BMD122-induced disruption of $\beta 4$ and c-Met interaction or a reduction in c-Met activity.

Both $\beta 4$ and c-Met can be activated by cellular adhesion, independent of the adhesive substrate (Trusolino et al. 2001; Wang et al. 1996). Consistent with previous reports (Trusolino et al. 2000), HGF increased cell adhesion to laminin in PC-3M cells (Figure 40). 3E1 stimulation also resulted in increased cellular adhesion. BMD122 treatment did not significantly reduce the HGF-induced cell adhesion, confirming that enzymatic inhibition of 12-LOX reduces HGF-induced invasion independent of cell adhesion.

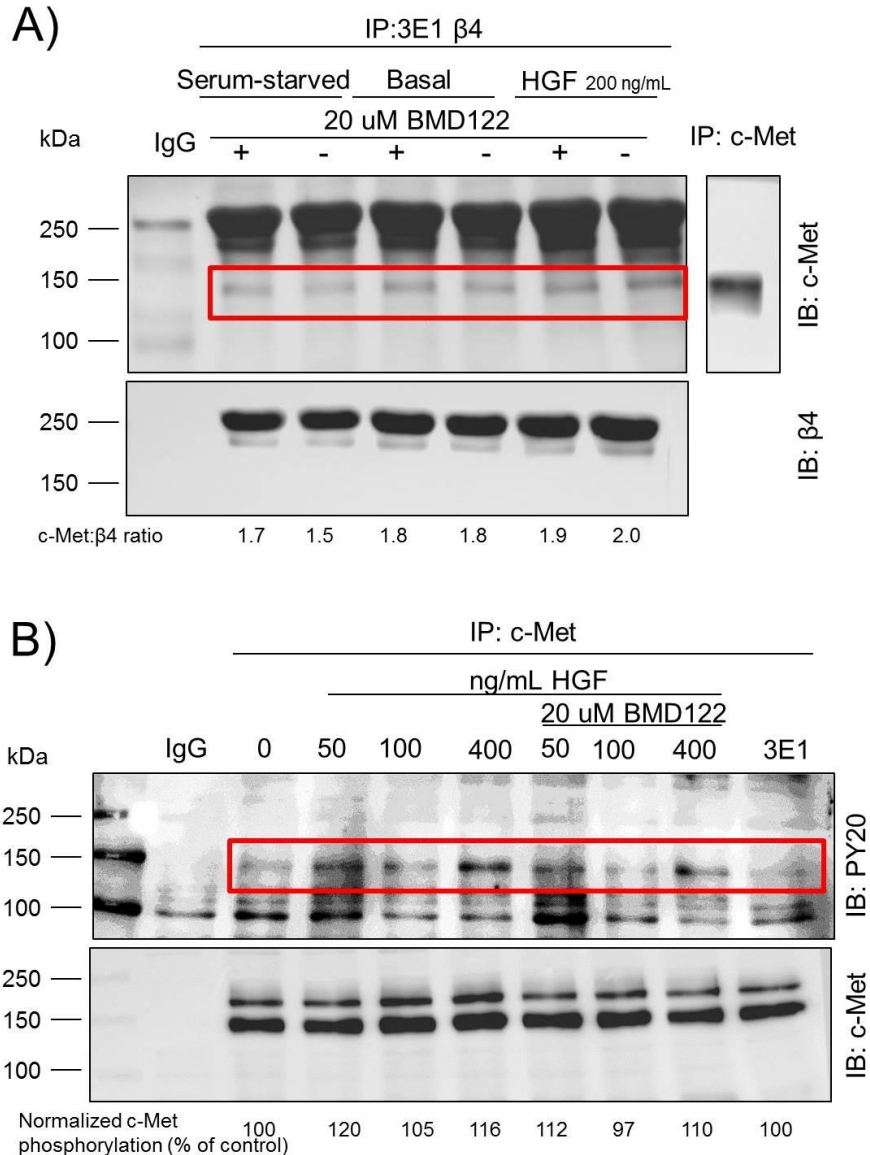

Figure 39. 12-LOX Enzymatic Inhibition Does Not Affect β 4 and c-Met Constitutive Association or c-Met Activation with HGF. A) Constitutive interaction of β 4 with c-Met is not affected by BMD122. Cells were pre-treated with 20 μ M BMD122 in serum-starved, basal (non-serum-starved), or HGF treated conditions. Lysates were immunoprecipitated for β 4 (using 3E1 antibodies) followed by Western blot analysis with c-Met. The blot was stripped and re-probed for total β 4. Matched IgG was immunoprecipitated as a control. Densitometry represents the ratio co-immunoprecipitated c-Met (upper panel) to immunoprecipitated β 4 (lower panel). B) HGF-induced c-Met phosphorylation is not affected by BMD122. Cells were pre-treated with 20 μ M BMD122, then treated with the indicated concentrations of HGF or 3E1 for 30 minutes. Lysates were immunoprecipitated for c-Met followed by Western blot analysis with PY20. The blot was stripped and re-probed for total c-Met. Matched IgG was immunoprecipitated as a control. Densitometry represents the ratio of phosphorylated c-Met (upper panel) to total c-Met (lower panel) normalized to the non-treated control.

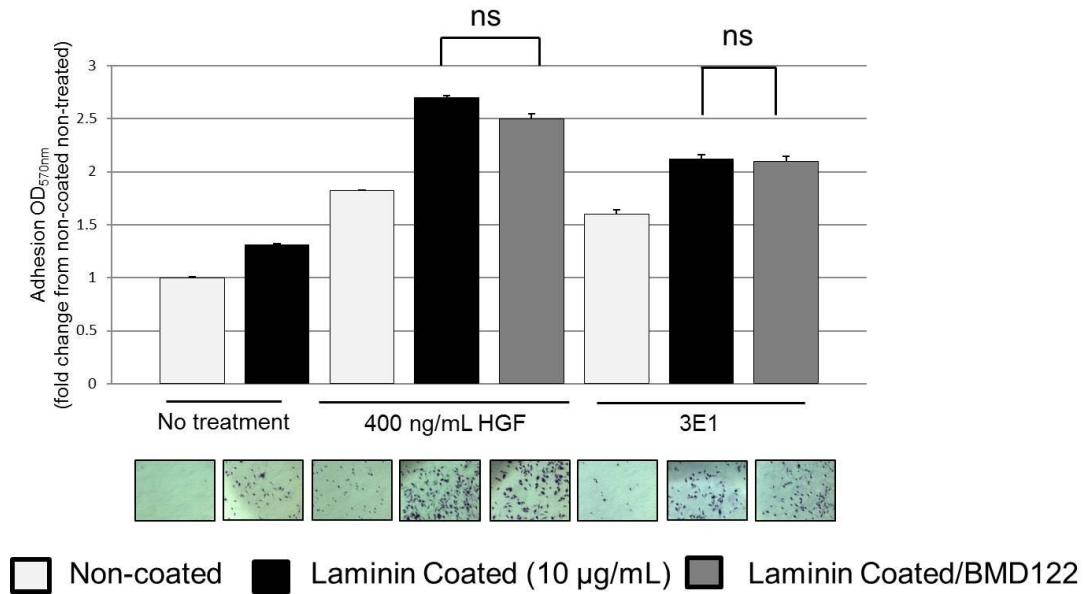

Figure 40. 12-LOX Enzymatic Inhibition Does Not Affect HGF-induced Cellular Adhesion. 12-LOX enzymatic inhibition with BMD122 does not affect HGF-induced cellular adhesion to laminin coated plates (10 µg/mL). Serum-starved cells were seeded onto laminin coated plates and then treated with HGF or 3E1. Where BMD122 was used, cells were pre-incubated for two hours prior to seeding onto plates. Non-coated plates were used as a control for laminin coating. Adhesion was quantified by measuring the absorbance of crystal violet stained cells (dissolved in 2% SDS) at OD_{550nm}. Results are representative of three replicates.

HGF-induced 12-LOX recruitment to $\beta 4$ does not result in increased 12(S)-HETE production in prostate cancer cells

To see if HGF-stimulated 12-LOX recruitment to $\beta 4$ results in 12(S)-HETE production, PC-3M cells were incubated with AA, the substrate for 12-LOX metabolism of 12(S)-HETE, for six hours. At the experimental end point, lipids were isolated by solid phase extraction from collected cell-conditioned media and analyzed by LC-MS. In the A431 positive control (3E1), there was an increase in 12(S)-HETE production. However, no increase in 12(S)-HETE was seen in the PC-3M cells after HGF stimulation (Figure 41). Collectively these data led us to the hypothesis that in addition to its enzymatic activity, 12-LOX plays a novel role as a scaffold between $\beta 4$ and c-Met to promote $\beta 4$ -enhanced HGF-induced invasion in prostate cancer cells.

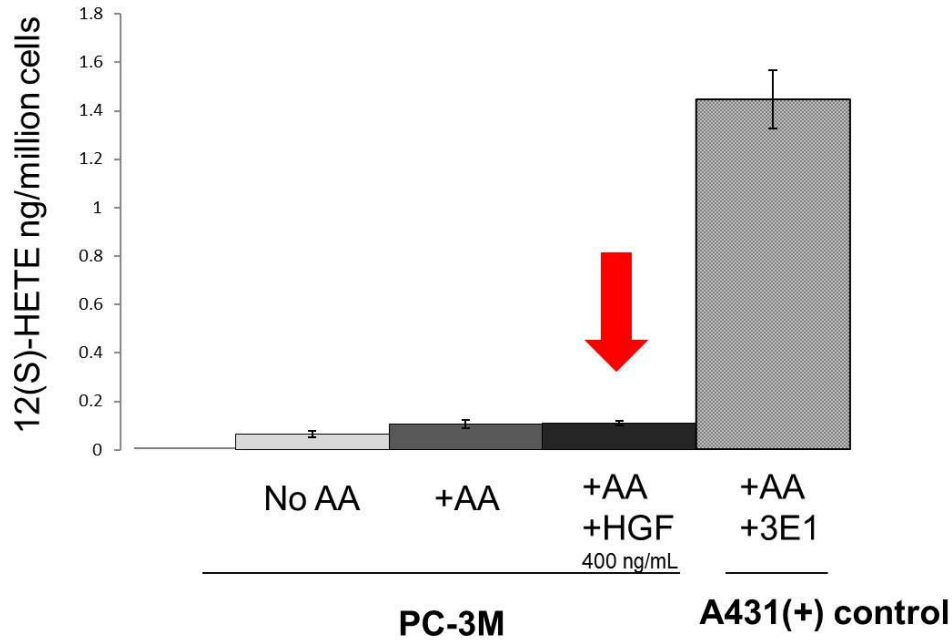

Figure 41. HGF Stimulation Does Not Increase 12(S)-HETE Production. LC-MS analysis of 12(S)-HETE production in PC-3M cells reveals HGF stimulation does not increase 12(S)-HETE levels. Cells were treated with HGF in the presence of AA (or not) for six hours following serum-starvation. A431 cells stimulated with 3E1 were used as a positive control for 12(S)-HETE measurement. Lipids from conditioned media were extracted as per standard protocols (see Material and Methods) and samples were analyzed by LC-MS. The results were analyzed in triplicate and represented +/- SEM.

Summary

As depicted in Figure 42, $\beta 4$ and c-Met interact constitutively in prostate cancer cells, regardless of c-Met activation by HGF. Direct stimulation of $\beta 4$ by 3E1 also did not affect the interaction. However, 12-LOX appears to be recruited to $\beta 4$ /c-Met on HGF stimulation compared to the positive control, 3E1 treatment. Additionally, c-Met activation via HGF led to $\beta 4$ tyrosine phosphorylation, but not at the Y1494 residue. Interestingly, even though $\beta 4$ -Y1494 was not activated following HGF stimulation, $\beta 4$ -Y1494 downstream signaling to AKT still occurs in prostate cancer cell lines. Despite 12-LOX being recruited to activated $\beta 4$, there was no activation of 12-LOX enzymatic activity. Instead, inhibition of 12-LOX enzymatic activity reduced HGF-induced invasion and this effect was not rescued by exogenous 12(S)-HETE production. These results are not explained by enzymatic inhibition of 12-LOX leading to decreased c-Met activation with HGF, a disruption of $\beta 4$ and c-Met interaction, or decreased HGF-induced cellular adhesion to laminin. These data lead us to the following conclusions for prostate cancer cells: 1. 12-LOX is a scaffold, acting to mediate $\beta 4$ enhancement of c-Met signaling/functioning in invasion, and 2. 12-LOX enzymatic activity may regulate its scaffolding function.

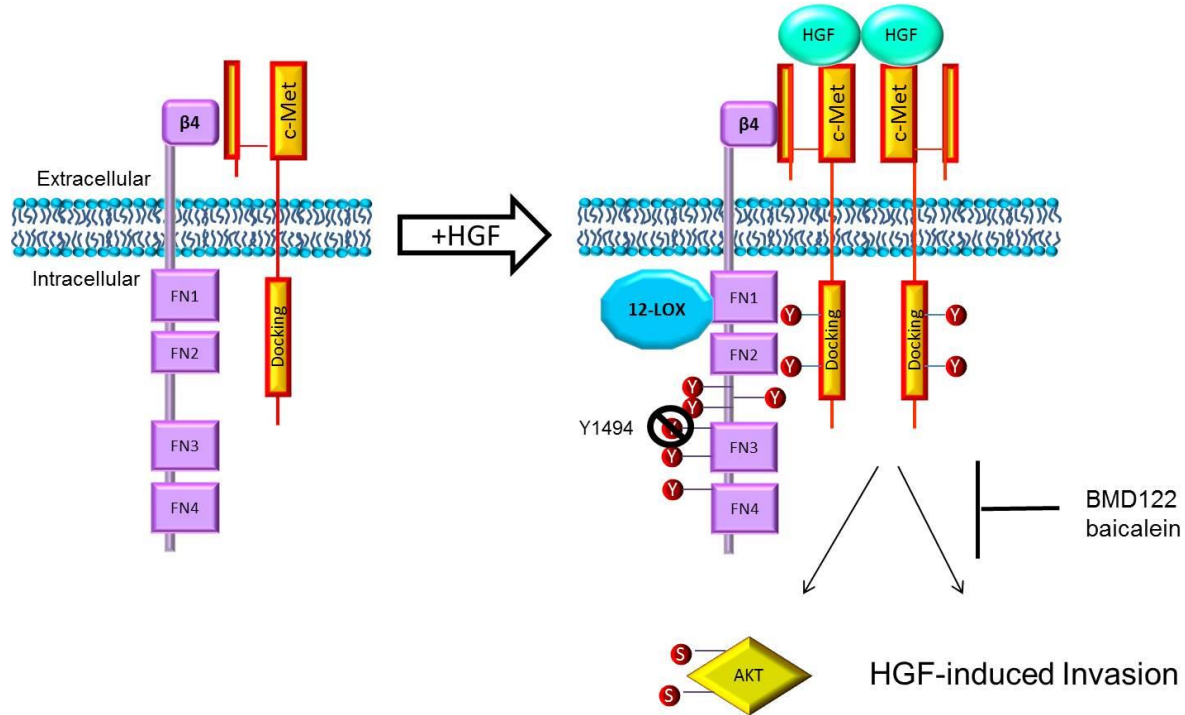

Figure 42. 12-LOX Acts as a Scaffold to Regulate β 4-enhanced c-Met-mediated Prostate Cancer Cell Invasion. β 4 and c-Met interact constitutively in prostate cancer cells, regardless of β 4 or c-Met activation by their cognate ligands. However, 12-LOX appears to be recruited to β 4/c-Met on HGF stimulation compared to the positive control, 3E1 treatment. Additionally, c-Met activation via HGF leads to β 4 tyrosine phosphorylation, but not at the β 4-Y1494 residue. Interestingly, even though β 4-Y1494 was not activated following HGF stimulation, β 4-Y1494 downstream signaling to AKT still occurs. Despite 12-LOX being recruited to activated β 4, there was no activation of 12-LOX enzymatic activity. Instead, inhibition of 12-LOX enzymatic activity reduced HGF-induced invasion, and this effect was not rescued by exogenous 12(S)-HETE production. These results are not explained by enzymatic inhibition of 12-LOX leading to decreased c-Met activation with HGF, a disruption of β 4 and c-Met interaction, or decreased HGF-induced cellular adhesion to laminin. These data lead us to the following conclusions for prostate cancer cells: 1. 12-LOX is a scaffold, acting to mediate β 4 enhancement of c-Met signaling/functioning in invasion, and 2. 12-LOX enzymatic activity may regulate its scaffolding function.

CHAPTER 4. DISCUSSION

In this study we sought to characterize the physical and functional cooperation of $\beta 4$, 12-LOX, and c-Met in terms of HGF-induced cell motility and the invasive potential of cancer cells. In A431 cells we found HGF stimulation led to the disruption of the $\beta 4$ and c-Met complex, likely due to the disruption of hemidesmosome-like structures, resulting in 12-LOX recruitment to $\beta 4$, but without an increase in 12-LOX enzymatic activity, i.e. no 12(S)-HETE production. Because of this puzzling observation – the fact that 12-LOX is recruited to activated $\beta 4$ but not itself enzymatically activated – we utilized shRNA targeted to 12-LOX to confirm its role in HGF-mediated functioning. We found this lipid enzyme to be required for HGF-induced, c-Met-mediated cross-activation of $\beta 4$ tyrosine phosphorylation and downstream signaling to AKT and ERK. Although HGF-mediated activation of both AKT and ERK was inhibited when 12-LOX was knocked down, the basal phosphorylation level of each protein was higher than that seen in the corresponding ns shRNA control, indicating that 12-LOX may work as a negative regulator of their activation. This conjecture seems inconsistent when considering the fact that 12-LOX enhances cell scattering and invasion, two phenotypes that require MAPK and RAS pathway activation (Potempa & Ridley 1998). The inability of the 12-LOX KD cells to scatter with HGF treatment may reflect the inhibition of ERK activation above a certain threshold, perhaps because it was not properly de-phosphorylated to begin with, as both 12-LOX knockdown and peptide inhibition of 12-LOX interaction with $\beta 4$ lead to reduced cell scattering/motility and reduced cell invasion in response to HGF. Therefore, we propose that 12-LOX is a novel scaffold, and in collaboration with $\beta 4$, acts to enhance the invasive signaling originating from c-Met on binding to HGF, modulating cancer cell scattering and invasion. To our knowledge, this is the first

demonstration that 12-LOX lipid enzyme can moonlight, or display more than one function, as a scaffold.

In prostate cancer cells, we found that $\beta 4$ and c-Met interact constitutively, regardless of activation by either of their cognate ligands. Despite low expression levels of 12-LOX, the enzyme appeared to be recruited to $\beta 4$ /c-Met on HGF stimulation, as well as with 3E1 activation of $\beta 4$. Overexpression of 12-LOX in PC-3M cells solidified the above observations, clearly indicating that 12-LOX interacts with $\beta 4$ following HGF or 3E1 stimulation. Additionally, c-Met activation via HGF led to $\beta 4$ tyrosine phosphorylation. Interestingly, even though $\beta 4$ -Y1494 was not activated following HGF stimulation in prostate cancer cells, like it was in A431 cells, $\beta 4$ -Y1494 downstream signaling to AKT still occurred in response to HGF. This could indicate two possibilities, first that these cells have developed an alternate method of AKT activation independent of $\beta 4$, or second that another residue beside $\beta 4$ -Y1494 signals downstream to AKT. Despite 12-LOX recruitment to activated $\beta 4$, there was no activation of 12-LOX enzymatic activity. However, inhibition of 12-LOX enzymatic activity nonetheless reduced HGF-induced invasion, an effect not rescued by exogenous 12(S)-HETE addition. These results cannot be explained by enzymatic inhibition of 12-LOX leading to decreased HGF-induced c-Met activation. Similarly, 12-LOX enzymatic inhibition leading to decreased cellular invasion cannot be explained by a disruption of $\beta 4$ and c-Met interaction with 12-LOX inhibition, as there was no effect on their constitutive association with BMD122 treatment. Therefore, when both proteins are endogenously expressed, 12-LOX, either acting as an enzyme or scaffold, does not impact $\beta 4$ and c-Met interaction. Lastly, enzymatic inhibition of 12-LOX leading to inhibited cellular invasion was not the result of decreased HGF-induced cellular adhesion. 12-LOX inhibition by BMD122 led to inhibited HGF-induced invasion, so we reasoned this might also inhibit cellular adhesion, which

may negatively affect invasion. However, HGF-induced cell adhesion was not affected by BMD122, consistent with idea that $\alpha3\beta1$, not $\beta4$, mediates initial adhesion and cell spreading (Kreidberg 2000). These prostate cancer cell data lead us to the following conclusions, which are consistent with those we inferred from the A431 cell line: 1) 12-LOX is a scaffold, acting to mediate $\beta4$ enhancement of c-Met signaling/functioning in invasion, and 2) 12-LOX enzymatic activity may regulate its scaffolding function.

In characterizing the physical and functional interactions of $\beta4$, 12-LOX, and c-Met, there were several notable differences and similarities in the data obtained with the A431 cell line compared to the prostate cancer cells. First, the relationship between c-Met and $\beta4$ in A431 cells was dissociative on HGF stimulation vs. being constitutive in the prostate cancer cell lines. While there may be many explanations for this difference, an important one is that A431 cells form hemidesmosomes while prostate cancer cells do not. Normal epithelial prostate cells form hemidesmosomes and somewhere in the progression of cancer the structures are disassembled to allow tumor cells to metastasize. This occurs because of many factors including overactive growth factor receptors, like c-Met, that stimulate matrix degradation, cell survival in hostile microenvironments, and invasion. Interestingly enough, the prostate cancer cells used in this study were all metastatic and the A431 cells were not. This could indicate a switch in integrin function from a mechano-adhesive device to one that actively aids in cellular migration/invasion. It is likely that $\beta4$ function is dictated by the ECM and type of substrate the cells are attached to, which then ultimately controls $\beta4$ interacting partners and this likely affects 12-LOX enzymatic or scaffolding function.

Yet, when 12-LOX was overexpressed in PC-3M cells, both HGF and 3E1 stimulation disrupted the $\beta4$ /c-Met complex, which suggests that at a certain threshold of expression, 12-LOX

is regulating $\beta 4$ and c-Met interaction. In prostate cancer cells where $\beta 4$ is not incorporated into hemidesmosomes, but is diffuse within the cell membrane and constitutively interacting with c-Met, perhaps 12-LOX is required for $\beta 4$ and c-Met dissociation after HGF stimulation. This question remains open until more rigorous experiments can be performed, as 12-LOX was never successfully knocked down using shRNA in the prostate cancer cell lines. Additionally, in PC-3 cells, 12-LOX overexpression did not affect $\beta 4$ and c-Met interaction, but these cells have significantly lower $\beta 4$ expression levels than PC-3M cells, which may explain the difference. However, in A431 cells, which do form hemidesmosomes, immunoprecipitation experiments using the 12-LOX knockdown cell line clearly indicated it makes no difference if 12-LOX is expressed in terms of $\beta 4$ and c-Met interaction under basal conditions or their dissociation after growth factor receptor activation. It is possible that when cancer cells progress in stage and/or grade that 12-LOX may be upregulated to confer increased sensitivity to $\beta 4$ -enhanced c-Met signaling, and then at the metastatic site turn 12-LOX off as it is no longer needed to induce tumorigenic phenotypes such as endothelial cell retraction (Tang et al. 1993), 12(S)-HETE production for motility (Timár et al. 1993), and MMP-9 production for matrix degradation (Dilly et al. 2013). In agreement with this hypothesis, most normal cells do not express 12-LOX, non-metastatic cancer cells like A431 cells do express it, and metastatic cancer cells like PC-3M express low levels.

In both A431 and the prostate cancer cell lines, HGF treatment resulted in 12-LOX recruitment to activated $\beta 4$ integrin without the corresponding increase in 12-LOX enzymatic activity. As mentioned above, these results were surprising to us considering the only known function of 12-LOX is as a lipid enzyme. Additionally, when we first characterized the relationship between $\beta 4$ and 12-LOX in A431 cells, direct stimulation of $\beta 4$ by laminin or 3E1 led to $\beta 4$

phosphorylation, followed by 12-LOX recruitment to the integrin and enzymatic activation. Even though 12-LOX was not enzymatically activated under HGF treatment conditions in the A431 or prostate cancer cells, several important pieces of data from both types of cell lines led us to the conclusion that in addition to its enzymatic activity, 12-LOX may actually be a scaffold required for $\beta 4$ and c-Met cooperation in cancer cells.

In A431 cells, 12-LOX knockdown decreased $\beta 4$ phosphorylation, downstream signaling to AKT and ERK, cell scattering, and invasion in response to HGF activation of c-Met. Inhibition of 12-LOX interaction with $\beta 4$ by the $\beta 4$ -derived fragments FNO1 or FNO1-2, also replicated the same phenotypes as 12-LOX knockdown. While we were unable to knockdown 12-LOX in PC-3M prostate cancer cell lines, enzymatic inhibition of 12-LOX led to a decrease in HGF-induced invasion. It is unclear why, if 12-LOX enzymatic activity was not important in this context, that enzymatic inhibition would result in decreased HGF-induced invasion. Perhaps inhibition of 12-LOX enzymatic activity alters its structure enough to preclude its scaffolding ability along with the ability of any additional adapters or signal transducers to bind. As seen in the LC-MS analysis, HGF stimulation of A431 cells actually suppressed 12-LOX enzymatic activity, and did not alter the activity in PC-3M cells, which appears to support our hypothesis.

It is accepted that growth factor stimulation of cell motility leads to the release of $\beta 4$ from hemidesmosomes where it subsequently associates with F-actin in lamellipodia (Frijns et al. 2010; Germain et al. 2009; Gipson et al. 1993; Mainiero et al. 1996; O'Connor et al. 1998; Rabinovitz et al. 1999; Trusolino et al. 2000). This topographical change in $\beta 4$ location allows it to interact with the growth factor receptors and kinases that are normally inaccessible to the integrin, leading to this alternate integrin activation. In non-cancerous cells the activation of $\beta 4$ is a tightly regulated phenomenon controlled by multiple complex mechanisms including the differentiation state of the

cell, protease activation, signaling cascades, tissue microenvironment, the ability to make adhesive contacts, cell survival, etc. However, in cancer cells where GFRs can be amplified, overexpressed, or constitutively active, like c-Met, certain stimuli (growth factors, chemoattractants, adhesion, etc.) can lead to uncontrollable $\beta 4$ activation via cross-activation resulting in enhanced GFR-initiated downstream signaling (Bertotti et al. 2006; Falcioni et al. 1997; Gambaletta et al. 2000; Guo et al. 2006; Hintermann et al. 2001; Santoro et al. 2003; Trusolino et al. 2001; Yoshioka et al. 2013). Interestingly enough, $\beta 4$ does not have to be bound to its natural ligand laminin or be heterodimerized with integrin $\alpha 6$ to function in cell signaling (Bertotti et al. 2005; Bertotti et al. 2006; Gambaletta et al. 2000; Merdek et al. 2007; Trusolino et al. 2001). Also of note are the observations that EGFR and c-Met interact and cross-talk in A431 cells, where c-Met can be activated by the EGFR (Dulak 2011; Jo et al. 2000). Therefore, it is possible that $\beta 4$ /c-Met/EGFR may be complexed together and facilitate cross-activation of one another on ligand stimulation.

Another group found that 24 hour EGF and HGF treatment of rat corneal epithelial cells lead to an increase in 12-LOX mRNA and protein levels followed by an increase in 12(S)-HETE, although EGF stimulated the most robust response (Ottino et al. 2003). Prior to that observation, EGF was shown to increase 12-LOX mRNA and activity in A431 cells within 10 hours (Chang et al. 1993). However there was confusion over which isoform of 12-LOX was being studied, leukocyte vs. platelet. While our study found no increase in 12-LOX activity with HGF stimulation at six or 24 hours, the difference can be interpreted several ways: we have observed that the protein levels of 12-LOX and $\beta 4$ can decrease with passage number, which likely affect cell responses to growth factors. In higher passage cells that have decreased or lost expression of 12-LOX, they may respond to growth factor stimulation by re-expressing and activating the enzyme. This may explain the HGF-stimulated 12(S)-HETE production seen by Ottino *et. al.*

Additionally, we evaluated 12(S)-HETE released into the media while the study by Ottino *et al.* combined both media and cells as a homogenate, collected the microsomal fraction through centrifugation and then measured 12(S)-HETE production. The difference is we were evaluating 12(S)-HETE production and secretion of intact cells while they were not. Our analysis does not rule out the possibility that HGF may stimulate 12-LOX activity in A431 cells as a *delayed response* to the chemoattractant, while the immediate function of 12-LOX is to act as a scaffold. The former would not be surprising given that c-Met activates PLA2, an enzyme responsible for cleaving AA from the membrane providing a substrate for 12-LOX (Hori 1993), and also activates SRC, a kinase we know to be responsible for 12-LOX activation following β 4 activation (Dilly *et al.* manuscript pending). The data above combined with this report collectively point toward a functional β 4 and c-Met complex in cancer cells.

Further evidence to support a functional relationship between β 4 and c-Met was the finding that β 4 expression upregulates the levels of Tiam1 (T-lymphoma invasion and metastasis), a Rac-specific guanine nucleotide exchange factor, after HGF stimulation of pancreatic adenocarcinoma cell lines to promote chemotaxis and invasion (Cruz-Monserrate & O'Connor 2008). The increased Tiam1 resulted in activated Rac1 and was necessary for HGF-induced cell motility (Cruz-Monserrate & O'Connor 2008). Another link between c-Met and β 4 is that they can both be controlled by the Ets family members of transcription factors (Gambarotta *et al.* 1996). Additionally, β 4 and c-Met both interact with the membrane tetraspanin CD151. Knockdown of CD151 decreased HGF-induced proliferation, anchorage independent growth, tumor progression in a mouse xenograft model, β 4 phosphorylation, and c-Met and β 4 complex formation (Franco *et al.* 2010). Studies using CD151 knockout mice showed CD151 expression increased the size, number, and time to malignant progression of squamous cell carcinoma through the promotion of

β 4-induced survival and proliferative signaling (Li 2012). This suggests that CD151 may be needed for β 4 and c-Met cooperative signaling, and may participate with 12-LOX, although we were never able to detect CD151 under our conditions.

Recently our lab showed that stable expression of GR16 in A431 cells blocked β 4 interaction with 12-LOX, resulting in reduced cell motility and invasion toward EGF in Boyden chamber assays, reduced 12(S)-HETE production as measured by LC-MS, and decreased colony formation and proliferation. A decrease in *in vivo* tumor formation in athymic nude mice using the GR16 stably transfected cells was also seen compared to controls (Joshi *et al.* manuscript pending). We hypothesize that the GR16 fragment, which includes the FNO1 and FNO1-2 peptides, is interacting with 12-LOX in the cytoplasm to prevent its binding to the membrane associated β 4, thereby preventing 12-LOX activation by β 4 at the cell surface. The observation that FNO1 and FNO1-2 peptides inhibit HGF-induced cell scattering and invasion combined with the findings above, strengthen the idea that targeting not only c-Met, but also β 4 and 12-LOX, will dramatically improve therapeutic efficacy in reducing tumor cell survival and therefore tumor cell aggressiveness. We have shown that β 4 enhances c-Met signaling to promote tumor growth, and this study is the first to identify 12-LOX as a novel scaffold for β 4-enhanced c-Met-induced cell scattering and invasion, which solidifies the importance of 12-LOX and β 4 interaction as a druggable target. Understanding how these proteins cooperate to promote tumor cell motility/invasion will allow for targeting multiple points of intersecting pathways. Combinational treatment will also likely reduce the drug resistance commonly seen with traditional, single-agent c-Met inhibitors in clinical trials. However, it remains to be determined what the combined effect of either peptide in addition to a c-Met inhibitor would have on tumor growth or progression *in vivo*, or even how the peptides would be delivered to cells. The peptides are only slightly

hydrophobic, and therefore cannot cross the cell membrane alone. Plus, *in vivo*, the un-capped peptides would be relatively unstable which would not allow efficacious treatment. However, biotechnology and nanotechnology advances are making peptides as therapeutic agents a viable reality. Additionally, the peptides could be used to screen for compounds or mimetics with similar inhibitory characteristics to treat cancer cells.

12-LOX importance to tumor progression as a lipid enzyme or scaffold extends much further than in tumor cells alone. Platelet 12-LOX got its name from being highly expressed in platelets, and it is widely accepted that platelets can play a role in tumor progression (reviewed in (Menter et al. 2014)). Specifically, platelets can be activated by receptors on tumor cells, tumor cell exosomes, or other secreted factors originating from tumor cells/leaky tumor vasculature. Once activated, platelets will degranulate to release bioactive lipids and other inflammatory factors into the bloodstream. This can lead to the recruitment, activation, and aggregation of other platelets. This can also lead to the recruitment of tumor cells. Additionally, by recognizing tumor cell receptors and thereby interacting with them, this can protect the tumor cells from immune system destruction. If enough platelets interact with the tumor cell(s), aggregates may arrest in the microvasculature, allowing the tumor cells to extravasate, as platelets regulate vascular integrity, and through the production of 12(S)-HETE stimulate endothelial cell retraction (Honn et al. 1994b). Tumor cells which express oncogenic c-Met would present with an extraordinary advantage in this situation. Given that 12-LOX acts as a scaffold to potentiate c-Met-mediated functioning, platelet production of 12(S)-HETE could serve to positively reinforce tumor cell 12-LOX expression, as has it has been shown that 12(S)-HETE potentiates 12-LOX (Guo et al. 2011b). Additionally, once arrested in circulation, tumor cells expressing oncogenic c-Met have the added advantage of exploiting c-Met-mediated invasion, metastasis, matrix degradation, and

EMT functions to establish secondary metastatic sites. To reiterate an earlier point, exogenous 12(S)-HETE has been shown to protect cells from serum-starved-induced apoptosis (Honn & Tang 1997; Tang et al. 1996), an effect that tumor cells also exploit, especially under the protection of β 4 and c-Met anti-apoptotic signaling.

One of the key ways tumor cells survive under hypoxic stress in both the primary and metastatic sites is through induction of angiogenesis, mediated by VEGF (Marschall et al. 2001; Shweiki et al. 1992). It has been shown that β 4 can influence VEGF translation and protein expression through phosphorylation of 4E-binding protein (4E-BP1). Essentially, stimulation of β 4 results in PI3K/AKT signaling (Bachelder et al. 1999a; Gambaletta et al. 2000; Hintermann et al. 2001; Shaw et al. 1997), the subsequent activation of mTOR (Sekulić et al. 2000), and consequent phosphorylation of 4E-BP1 resulting in disruption of its binding to eukaryotic translation initiation factor 4E (eIF-4E) (Chung et al. 2002). Once eIF-4E is freed, it can initiate translation of proteins such as VEGF. Interestingly, β 4-Y1494 phosphorylation is critical for β 4 induced VEGF expression (Chung et al. 2002), and this is likely to involve 12-LOX. In support of this conjecture is the fact that mice lacking the cytoplasmic tail of β 4, meaning 12-LOX and β 4 could no longer interact, had a reduced angiogenic response to hypoxia as well as reduced angiogenesis induced by VEGF (Nikolopoulos et al. 2004). Our lab has shown that 12-LOX controls HIF1 α under hypoxic conditions, MMP9 activity via 12(S)-HETE production, and angiogenesis through regulation of VEGF expression (Dilly et al. 2013; Krishnamoorthy et al. 2010; Nie et al. 2006). Gene expression analysis of tissue from mice injected subcutaneously with A431 cells stably expressing GR16 (to inhibit β 4 and 12-LOX interaction) show a decrease in VEGF, HIF1 α , and BCL-2 mRNA levels while Bax levels were increased (Joshi *et al.* manuscript pending) indicating decreased angiogenesis and increased cell apoptosis. c-Met also controls

angiogenesis, protease secretion or activation for tissue remodeling/cell motility/invasion, and is itself controlled by HIF1 α in hypoxia (Jeffers et al. 1996; Meiners et al. 1998). There are many clinical trials aimed at inhibiting angiogenesis by using VEGF inhibitors. Therefore, the findings of this study where 12-LOX and β 4 could be modulated to impact c-Met and/or VEGF open a novel approach to tumor therapy.

In summary, tumor cells coordinate the cooperative orchestration of β 4, 12-LOX, and c-Met signaling in tumor progression to promote invasion, metastasis, angiogenesis, and cell survival. This study reports for the first time the finding that 12-LOX acts as a novel scaffold to regulate β 4-enhanced c-Met-mediated cancer cell scattering and invasion. This not only expands our knowledge of how tumor cells invade, which is absolutely crucial to prevent the deadly metastasis of cancer, but it uncovered a novel target for cancer therapeutics. The unorthodox function of 12-LOX as a scaffold may also enforce the idea of evaluating proteins from a new perspective, and therefore lead to even more exciting discoveries. These findings have the ability to impact the survival and prognosis of cancer patients, and have opened new avenues of research for systems biology, protein-protein interaction, and cross-talk mechanisms.

REFERENCES

- Abdel-Ghany, M., Cheng, H.-C., Elble, R. C., Pauli, B. U. 2002. Focal Adhesion Kinase Activated by $\beta 4$ Integrin Ligation to mCLCA1 Mediates Early Metastatic Growth. *Journal of Biological Chemistry* 277, 34391-34400.
- Abounader, R., Laterra, J. 2005. Scatter factor/hepatocyte growth factor in brain tumor growth and angiogenesis. *Neuro-Oncology* 7, 436-451.
- Augustsson, K., Michaud, D., Rimm, E., Leitzmann, M., Stampfer, M., Willett, W., Giovannucci, E. 2003. A prospective study of intake of fish and marine fatty acids and prostate cancer. *cancer Epidemiol Biomarkers Prev.* 12, 64-67.
- Baba, A., Sakuma, S., Okamoto, H., Inoue, T., Iwata, H. 1989. Calcium induces membrane translocation of 12-lipoxygenase in rat platelets. *Journal of Biological Chemistry* 264, 15790-15795.
- Bachelder, R. E., Marchetti, A., Falcioni, R., Soddu, S., Mercurio, A. M. 1999a. Activation of p53 Function in Carcinoma Cells by the $\alpha 6\beta 4$ Integrin. *Journal of Biological Chemistry* 274, 20733-20737.
- Bachelder, R. E., Ribick, M. J., Marchetti, A., Falcioni, R., Soddu, S., Davis, K. R., Mercurio, A. M. 1999b. P53 Inhibits $\alpha 6\beta 4$ Integrin Survival Signaling by Promoting the Caspase 3-Dependent Cleavage of Akt/PKB. *The Journal of Cell Biology* 147, 1063-1072.
- Berquin, I., Min, Y., Wu, J., Perry, D., Cline, J. M., Thomas, M. J., Thornburg, T., Kulik, G., Smith, A., Edwards, I. J., D'Agostino, R., Zhang, H., Hong, W., Kang, J. X., Chen, Y. Q. 2007. Modulation of prostate cancer genetic risk by omega-3 and omega-6 fatty acids. *The Journal of Clinical Investigation* 117, 1866-1875.

- Bertotti, A., Comoglio, P. M., Trusolino, L. 2005. β 4 Integrin Is a Transforming Molecule that Unleashes Met Tyrosine Kinase Tumorigenesis. *Cancer Research* 65, 10674-10679.
- Bertotti, A., Comoglio, P. M., Trusolino, L. 2006. Beta4 integrin activates a Shp2-Src signaling pathway that sustains HGF-induced anchorage-independent growth. *J Cell Biol* 175, 993-1003.
- Bladt, F., Riethmacher, D., Isenmann, S., Aquzzi, A., Birchmeier, C. 1995. Essential role for the c-met receptor in the migration of myogenic precursor cells into the limb bud. *Nature (London)* 376, 768-771.
- Boeglin, W. E., Kim, R. B., Brash, A. R. 1998. A 12R-lipoxygenase in human skin: mechanistic evidence, molecular cloning, and expression. *Proceedings of the National Academy of Sciences - PNAS* 95, 6744-6749.
- Boon, E. M. J., van der Neut, R., van de Wetering, M., Clevers, H., Pals, S. T. 2002. Wnt Signaling Regulates Expression of the Receptor Tyrosine Kinase Met in Colorectal Cancer. *Cancer Research* 62, 5126-5128.
- Borradori, L., Sonnenberg, A. 1999. Structure and function of hemidesmosomes: more than simple adhesion complexes. *Journal of investigative dermatology* 112, 411-418.
- Bottaro, D. P., Rubin, J. S., Faletto, D. L., Chan, A. M., Kmieciak, T. E., Vande Woude, G. F., Aaronson, S. A. 1991. Identification of the hepatocyte growth factor receptor as the c-met proto-oncogene product. *Science (New York, N.Y.)* 251, 802-804.
- Brash, A. R. 1999. Lipoxygenases: Occurrence, Functions, Catalysis, and Acquisition of Substrate. *Journal of Biological Chemistry* 274, 23679-23682.
- Bussolino, F., Di Renzo, M. F., Ziche, M., Bocchietto, E., Olivero, M., Naldini, L., Gaudino, G., Tamagnone, L., Coffer, A., Comoglio, P. M. 1992. Hepatocyte growth factor is a potent

- angiogenic factor which stimulates endothelial cell motility and growth. *The Journal of Cell Biology* 119, 629-641.
- Carico, E., French, D., Bucci, B., Falcioni, R., Vecchione, A., Mariani Costantini, R. 1993. Integrin beta 4 expression in the neoplastic progression of cervical epithelium. *Gynecologic Oncology* 49, 61-66.
- Chang, W. C., Liu, Y. W., Ning, C. C., Suzuki, H., Yoshimoto, T., Yamamoto, S. 1993. Induction of arachidonate 12-lipoxygenase mRNA by epidermal growth factor in A431 cells. *Journal of Biological Chemistry* 268, 18734-18739.
- Chao, C., Lotz, M. M., Clarke, A. C., Mercurio, A. M. 1996. A Function for the Integrin $\alpha 6\beta 4$ in the Invasive Properties of Colorectal Carcinoma Cells. *Cancer Research* 56, 4811-4819.
- Chen, Y. Q., Duniec, Z. M., Liu, B., Hagmann, W., Gao, X., Shimoji, K.-i., Marnett, L. J., Johnson, C. R., Honn, K. 1994. Endogenous 12(S)-HETE Production by Tumor Cells and Its Role in Metastasis. *Cancer Research* 54, 1574-1579.
- Chung, J., Bachelder, R. E., Lipscomb, E. A., Shaw, L. M., Mercurio, A. M. 2002. Integrin ($\alpha 6\beta 4$) regulation of eIF-4E activity and VEGF translation: a survival mechanism for carcinoma cells. *The Journal of Cell Biology* 158, 165-174.
- Chung, J., Yoon, S.-O., Lipscomb, E. A., Mercurio, A. M. 2004. The Met Receptor and $\alpha 6\beta 4$ Integrin Can Function Independently to Promote Carcinoma Invasion. *Journal of Biological Chemistry* 279, 32287-32293.
- Connolly, J. M., Rose, D. P. 1998. Enhanced angiogenesis and growth of 12-lipoxygenase gene-transfected MCF-7 human breast cancer cells in athymic nude mice. *Cancer letters* 132, 107-112.

- Cowin, A. J., Adams, D., Geary, S. M., Wright, M. D., Jones, J. C., Ashman, L. K. 2006. Wound healing is defective in mice lacking tetraspanin CD151. *Journal of investigative dermatology* 126, 680-689.
- Cruz-Monserrate, Z., O'Connor, K. L. 2008. Integrin alpha 6 beta 4 promotes migration, invasion through Tiam1 upregulation, and subsequent Rac activation. *Neoplasia (New York, N.Y.)* 10, 408-417.
- Cruz-Monserrate, Z., Qiu, S., Evers, B. M., O'Connor, K. L. 2007. Upregulation and redistribution of integrin alpha6beta4 expression occurs at an early stage in pancreatic adenocarcinoma progression. *Modern pathology* 20, 656-667.
- Dans, M., Gagnoux-Palacios, L., Blaikie, P., Klein, S., Mariotti, A., Giancotti, F. G. 2001. Tyrosine Phosphorylation of the $\beta 4$ Integrin Cytoplasmic Domain Mediates Shc Signaling to Extracellular Signal-regulated Kinase and Antagonizes Formation of Hemidesmosomes. *Journal of Biological Chemistry* 276, 1494-1502.
- Davis, T. L., Cress, A. E., Dalkin, B. L., Nagle, R. B. 2001. Unique expression pattern of the $\alpha 6\beta 4$ integrin and laminin-5 in human prostate carcinoma. *The Prostate* 46, 240-248.
- de Lorgeril, M., Salen, P. 2012. New insights into the health effects of dietary saturated and omega-6 and omega-3 polyunsaturated fatty acids. *BMC Medicine* 10, 50.
- de Lorgeril, M., Salen, P., Martin, J., Monjaud, I., Boucher, P., Mamelle, N. 1998. Mediterranean dietary pattern in a randomized trial: Prolonged survival and possible reduced cancer rate. *Archives of Internal Medicine* 158, 1181-1187.
- De Marzo, N., Sloane, D. L., Dicharry, S., Highland, E., Sigal, E. 1992. Cloning and expression of an airway epithelial 12-lipoxygenase. *American Journal of Physiology - Lung Cellular and Molecular Physiology* 262, L198-L207.

- Di Renzo, M. F., Olivero, M., Giacomini, A., Porte, H., Chastre, E., Mirossay, L., Nordlinger, B., Bretti, S., Bottardi, S., Giordano, S. 1995. Overexpression and amplification of the met/HGF receptor gene during the progression of colorectal cancer. *Clinical Cancer Research* 1, 147-154.
- Di Renzo, M. F., Olivero, M., Martone, T., Maffe, A., Maggiora, P., Stefani, A. D., Valente, G., Giordano, S., Cortesina, G., Comoglio, P. M. 2000. Somatic mutations of the MET oncogene are selected during metastatic spread of human HNSC carcinomas. *Oncogene* 19, 1547-1555.
- Dilly, A.-K., Ekambaram, P., Guo, Y., Cai, Y., Tucker, S. C., Fridman, R., Kandouz, M., Honn, K. V. 2013. Platelet-type 12-lipoxygenase induces MMP9 expression and cellular invasion via activation of PI3K/Akt/NF- κ B. *International journal of cancer* 133, 1784-1791.
- Ding, X. Z., Kuszynski, C. A., El-Metwally, T. H., Adrian, T. E. 1999. Lipoxygenase inhibition induced apoptosis, morphological changes, and carbonic anhydrase expression in human pancreatic cancer cells. *Biochemical and Biophysical Research Communications* 266, 392-399.
- Dowling, J., Yu, Q. C., Fuchs, E. 1996. Beta4 integrin is required for hemidesmosome formation, cell adhesion and cell survival. *The Journal of Cell Biology* 134, 559-572.
- Dulak, A. M. 2011. HGF-independent potentiation of EGFR action by c-Met. *Oncogene* 30, 3625-3635.
- Dutta, U., Shaw, L. M. 2008. A Key Tyrosine (Y1494) in the β 4 Integrin Regulates Multiple Signaling Pathways Important for Tumor Development and Progression. *Cancer Research* 68, 8779-8787.

- Einheber, S., Milner, T. A., Giancotti, F. G., Salzer, J. L. 1993. Axonal regulation of Schwann cell integrin expression suggests a role for alpha 6 beta 4 in myelination. *The Journal of Cell Biology* 123, 1223-1236.
- Elsherbiny, M. E., Emara, M., Godbout, R. 2013. Interaction of brain fatty acid-binding protein with the polyunsaturated fatty acid environment as a potential determinant of poor prognosis in malignant glioma. *Progress in Lipid Research* 52, 562-570.
- Engelman, J. A., Zejnullahu, K., Mitsudomi, T., Song, Y., Hyland, C., Park, J. O., Lindeman, N., Gale, C.-M., Zhao, X., Christensen, J., Kosaka, T., Holmes, A. J., Rogers, A. M., Cappuzzo, F., Mok, T., Lee, C., Johnson, B. E., Cantley, L. C., Jänne, P. A. 2007. MET Amplification Leads to Gefitinib Resistance in Lung Cancer by Activating ERBB3 Signaling. *Science* 316, 1039-1043.
- Falcioni, R., Antonini, A., Nisticò, P., Stefano, S. D., Crescenzi, M., Natali, P. G., Sacchi, A. 1997. $\alpha 6\beta 4$ and $\alpha 6\beta 1$ Integrins Associate with ErbB-2 in Human Carcinoma Cell Lines. *Experimental Cell Research* 236, 76-85.
- Falcioni, R., Sacchi, A., Resau, J., Kennel, S. J. 1988. Monoclonal Antibody to Human Carcinoma-associated Protein Complex: Quantitation in Normal and Tumor Tissue. *Cancer Research* 48, 816-821.
- Falcioni, R., Turchi, V., Vitullo, P., Navarra, G., Ficari, F., Cavaliere, F., Sacchi, A., Mariani Costantini, R. 1994. Integrin Beta-4 expression in colorectal-cancer. *International journal of oncology* 5, 573-578.
- Ferracini, R., Di Renzo, M. F., Scotlandi, K., Baldini, N., Olivero, M., Lollini, P., Cremona, O., Campanacci, M., Comoglio, P. M. 1995. The Met/HGF receptor is over-expressed in

human osteosarcomas and is activated by either a paracrine or an autocrine circuit. *Oncogene* 10, 739-749.

Franco, M., Muratori, C., Corso, S., Tenaglia, E., Bertotti, A., Capparuccia, L., Trusolino, L., Comoglio, P. M., Tamagnone, L. 2010. The Tetraspanin CD151 Is Required for Met-dependent Signaling and Tumor Cell Growth. *Journal of Biological Chemistry* 285, 38756-38764.

Frijns, E., Sachs, N., Kreft, M., Wilhelmsen, K., Sonnenberg, A. 2010. EGF-induced MAPK Signaling Inhibits Hemidesmosome Formation through Phosphorylation of the Integrin $\beta 4$. *Journal of Biological Chemistry* 285, 37650-37662.

Fujita, M., Ieguchi, K., Davari, P., Yamaji, S., Taniguchi, Y., Sekiguchi, K., Takada, Y. K., Takada, Y. 2012. Cross-talk between Integrin $\alpha 6\beta 4$ and Insulin-like Growth Factor-1 Receptor (IGF1R) through Direct $\alpha 6\beta 4$ Binding to IGF1 and Subsequent $\alpha 6\beta 4$ -IGF1-IGF1R Ternary Complex Formation in Anchorage-independent Conditions. *Journal of Biological Chemistry* 287, 12491-12500.

Funk, C. D. 1996. The molecular biology of mammalian lipoxygenases and the quest for eicosanoid functions using lipoxygenase-deficient mice. *Biochimica et biophysica acta* 1304, 65-84.

Funk, C. D., Furci, L., FitzGerald, G. A. 1990. Molecular cloning, primary structure, and expression of the human platelet/erythroleukemia cell 12-lipoxygenase. *Proceedings of the National Academy of Sciences* 87, 5638-5642.

Gagnoux-Palacios, L., Dans, M., van't Hof, W., Mariotti, A., Pepe, A., Meneguzzi, G., Resh, M. D., Giancotti, F. G. 2003. Compartmentalization of integrin $\alpha 6\beta 4$ signaling in lipid rafts. *The Journal of Cell Biology* 162, 1189-1196.

- Gambaletta, D., Marchetti, A., Benedetti, L., Mercurio, A. M., Sacchi, A., Falcioni, R. 2000. Cooperative Signaling between $\alpha 6\beta 4$ Integrin and ErbB-2 Receptor Is Required to Promote Phosphatidylinositol 3-Kinase-dependent Invasion. *Journal of Biological Chemistry* 275, 10604-10610.
- Gambarotta, G., Boccaccio, C., Giordano, S., Ando, M., Stella, M. C., Comoglio, P. M. 1996. Ets up-regulates MET transcription. *Oncogene* 13, 1911-1917.
- Gao, X., Grignon, D. J., Chbihi, T., Zacharek, A., Chen, Y. Q., Sakr, W., Porter, A. T., Crissman, J. D., Edson Pontes, J., Powell, I. J., Honn, K. V. 1995. Elevated 12-lipoxygenase mRNA expression correlates with advanced stage and poor differentiation of human prostate cancer. *Urology* 46, 227-237.
- Garcia, S., Dalès, J.-P., Charafe-Jauffret, E., Carpentier-Meunier, S., Andrac-Meyer, L., Jacquemier, J., Andonian, C., Lavaut, M.-N., Allasia, C., Bonnier, P., Charpin, C. 2007. Poor prognosis in breast carcinomas correlates with increased expression of targetable CD146 and c-Met and with proteomic basal-like phenotype. *Human Pathology* 38, 830-841.
- Geerts, D., Fontao, L., Nievers, M. G., Schaapveld, R. Q., Purkis, P. E., Wheeler, G. N., Lane, E. B., Leigh, I. M., Sonnenberg, A. 1999. Binding of integrin $\alpha 6\beta 4$ to plectin prevents plectin association with F-actin but does not interfere with intermediate filament binding. *The Journal of Cell Biology* 147, 417-434.
- Germain, E. C., Santos, T. M., Rabinovitz, I. 2009. Phosphorylation of a Novel Site on the $\beta 4$ Integrin at the Trailing Edge of Migrating Cells Promotes Hemidesmosome Disassembly. *Mol. Biol. Cell* 20, 56-67.

- Gherardi, E. 2012. Targeting MET in cancer: rationale and progress. *Nature reviews. Cancer* 12, 89-103.
- Gherardi, E., Gray, J., Stoker, M., Perryman, M., Furlong, R. 1989. Purification of scatter factor, a fibroblast-derived basic protein that modulates epithelial interactions and movement. *Proceedings of the National Academy of Sciences* 86, 5844-5848.
- Gherardi, E., Youles, M. E., Miguel, R. N., Blundell, T. L., Iamele, L., Gough, J., Bandyopadhyay, A., Hartmann, G., Butler, P. J. G. 2003. Functional map and domain structure of MET, the product of the c-met protooncogene and receptor for hepatocyte growth factor/scatter factor. *Proceedings of the National Academy of Sciences* 100, 12039-12044.
- Giancotti, F. G., Stepp, M. A., Suzuki, S., Engvall, E., Ruoslahti, E. 1992. Proteolytic processing of endogenous and recombinant beta 4 integrin subunit. *The Journal of Cell Biology* 118, 951-959.
- Gipson, I. K., Spurr-Michaud, S., Tisdale, A., Elwell, J., Stepp, M. A. 1993. Redistribution of the Hemidesmosome Components [alpha]6[beta]4 Integrin and Bullous Pemphigoid Antigens during Epithelial Wound Healing. *Experimental Cell Research* 207, 86-98.
- Grant, D. S., Kleinman, H. K., Goldberg, I. D., Bhargava, M. M., Nickoloff, B. J., Kinsella, J. L., Polverini, P., Rosen, E. M. 1993. Scatter factor induces blood vessel formation in vivo. *Proceedings of the National Academy of Sciences* 90, 1937-1941.
- Gu, J. L., Natarajan, R., Ben-Ezra, J., Valente, G., Scott, S., Yoshimoto, T., Yamamoto, S., Rossi, J. J., Nadler, J. L. 1994. Evidence that a leukocyte type of 12-lipoxygenase is expressed and regulated by angiotensin II in human adrenal glomerulosa cells. *Endocrinology (Philadelphia)* 134, 70-77.

- Guo, A. M., Liu, X. H., Al-Wahab, Z., Maddipati, K., Ali-Fehmi, R., Scicli, A. G., Munkarah, A. R. 2011a. Role of 12-lipoxygenase in regulation of ovarian cancer cell proliferation and survival. *Cancer chemotherapy and pharmacology* 68, 1273-1283.
- Guo, W., Giancotti, F. G. 2004. Integrin signalling during tumour progression. *Nat Rev Mol Cell Biol* 5, 816-826.
- Guo, W., Pylayeva, Y., Pepe, A., Yoshioka, T., Muller, W. J., Inghirami, G., Giancotti, F. G. 2006. β 4 Integrin Amplifies ErbB2 Signaling to Promote Mammary Tumorigenesis. *Cell* 126, 489-502.
- Guo, Y., Zhang, W., Giroux, C., Cai, Y., Ekambaram, P., Dilly, A.-k., Hsu, A., Zhou, S., Maddipati, K. R., Liu, J., Joshi, S., Tucker, S. C., Lee, M.-J., Honn, K. V. 2011b. Identification of the Orphan G Protein-coupled Receptor GPR31 as a Receptor for 12-(S)-Hydroxyeicosatetraenoic Acid. *Journal of Biological Chemistry* 286, 33832-33840.
- Haenszel, W., Kurihara, M. 1968. Studies of Japanese migrants. I. Mortality from cancer and other diseases among Japanese in the United States. *JNCI : Journal of the National Cancer Institute* 40, 43-68.
- Hagmann, W., Gao, X., Timar, J., Chen, Y. Q., Strohmaier, A.-R., Fahrenkopf, C., Kagawa, D., Lee, M., Zacharek, A., Honn, K. V. 1996. 12-Lipoxygenase in A431 cells: genetic identity, modulation of expression, and intracellular localization. *Experimental Cell Research* 228, 197-205.
- Hagmann, W., Kagawa, D., Renaud, C., Honn, K. V. 1993. Activity and protein distribution of 12-lipoxygenase in HEL cells: Induction of membrane-association by phorbol ester TPA, modulation of activity by glutathione and 13-HPODE, and Ca^{2+} -dependent translocation to membranes. *Prostaglandins* 46, 471-477.

- Hall, P. A., Coates, P., Lemoine, N. R., Horton, M. A. 1991. Characterization of integrin chains in normal and neoplastic human pancreas. *The Journal of pathology* 165, 33-41.
- Hansbrough, J. R., Takahashi, Y., Ueda, N., Yamamoto, S., Holtzman, M. J. 1990. Identification of a novel arachidonate 12-lipoxygenase in bovine tracheal epithelial cells distinct from leukocyte and platelet forms of the enzyme. *Journal of Biological Chemistry* 265, 1771-1776.
- Hao, J., Yang, Y. J., McDaniel, K. M., Dalkin, B. L., Cress, A. E., Nagle, R. B. 1996. Differential expression of laminin 5 (alpha 3 beta 3 gamma 2) by human malignant and normal prostate. *The American Journal of Pathology* 149, 1341-1349.
- Hartmann, G., Weidner, K. M., Schwartz, H., Birchmeier, W. 1994. The motility signal of scatter factor/hepatocyte growth factor mediated through the receptor tyrosine kinase met requires intracellular action of Ras. *J Biol Chem* 269, 21936-21939.
- Hintermann, E., Bilban, M., Sharabi, A., Quaranta, V. 2001. Inhibitory Role of $\alpha 6\beta 4$ -Associated Erbb-2 and Phosphoinositide 3-Kinase in Keratinocyte Haptotactic Migration Dependent on $\alpha 3\beta 1$ Integrin. *The Journal of Cell Biology* 153, 465-478.
- Hogervorst, F., Kuikman, I., von dem Borne, A. E., Sonnenberg, A. 1990. Cloning and sequence analysis of beta-4 cDNA: an integrin subunit that contains a unique 118 kd cytoplasmic domain. *The EMBO journal* 9, 765-770.
- Honn, K., Tang, D. G., Gao, X., Butovich, I., Liu, B., Timar, J., Hagmann, W. 1994a. 12-lipoxygenases and 12(S)-HETE: role in cancer metastasis. *Cancer and Metastasis Reviews* 13, 365-396.

- Honn, K. V., Grossi, I. M., Diglio, C. A., Wojtukiewicz, M., Taylor, J. D. 1989. Enhanced tumor cell adhesion to the subendothelial matrix resulting from 12(S)-HETE-induced endothelial cell retraction. *The FASEB Journal* 3, 2285-2293.
- Honn, K. V., Tang, D. G. 1997. Eicosanoid 12(S)-HETE upregulates endothelial cell alpha V beta 3 integrin expression and promotes tumor cell adhesion to vascular endothelium. *Advances in experimental medicine and biology* 400B, 765-773.
- Honn, K. V., Tang, D. G., Grossi, I. M., Duniec, Z. M., Timár, J., Renaud, C., Leithauser, M., Blair, I., Johnson, C. R., Diglio, C. A., Kimler, V. A., Taylor, J. D., Marnett, L. J. 1994b. Tumor cell-derived 12(S)-hydroxyeicosatetraenoic acid induces microvascular endothelial cell retraction. *Cancer research (Baltimore)* 54, 565-574.
- Honn, K. V., Timár, J., Rozhin, J., Bazaz, R., Sameni, M., Ziegler, G., Sloane, B. F. 1994c. A Lipoxygenase Metabolite, 12-(S)-HETE, Stimulates Protein Kinase C-Mediated Release of Cathepsin B from Malignant Cells. *Experimental Cell Research* 214, 120-130.
- Hori, T. 1993. Stimulation of prostaglandin production by hepatocyte growth factor in human gastric carcinoma cells. *FEBS letters* 334, 331-334.
- Humphrey, P., Zhu, X., Zarnegar, R., Swanson, P., Ratliff, T., Vollmer, R., Day, M. 1995. Hepatocyte growth factor and its receptor (c-MET) in prostatic carcinoma. *Am J Pathol* 147, 386-396.
- Hynes, R. O. 2002. Integrins: Bidirectional, Allosteric Signaling Machines. *Cell* 110, 673-687.
- Ivanov, I., Di Venere, A., Horn, T., Scheerer, P., Nicolai, E., Stehling, S., Richter, C., Skrzypczak-Jankun, E., Mei, G., Maccarrone, M., Kühn, H. 2011. Tight association of N-terminal and catalytic subunits of rabbit 12/15-lipoxygenase is important for protein stability and

- catalytic activity. *Biochimica et Biophysica Acta (BBA) - Molecular and Cell Biology of Lipids* 1811, 1001-1010.
- Izumi, T., Hoshiko, S., Rådmark, O., Samuelsson, B. 1990. Cloning of the cDNA for human 12-lipoxygenase. *Proceedings of the National Academy of Sciences* 87, 7477-7481.
- Jagadeeswaran, R., Ma, P. C., Seiwert, T. Y., Jagadeeswaran, S., Zumba, O., Nallasura, V., Ahmed, S., Filiberti, R., Paganuzzi, M., Puntoni, R., Kratzke, R. A., Gordon, G. J., Sugarbaker, D. J., Bueno, R., Janamanchi, V., Bindokas, V. P., Kindler, H. L., Salgia, R. 2006. Functional Analysis of c-Met/Hepatocyte Growth Factor Pathway in Malignant Pleural Mesothelioma. *Cancer Research* 66, 352-361.
- Jeffers, M., Rong, S., Vande Woude, G. F. 1996. Hepatocyte growth factor/scatter factor-Met signaling in tumorigenicity and invasion/metastasis. *Journal of molecular medicine (Berlin, Germany)* 74, 505-513.
- Jeffers, M., Schmidt, L., Nakaigawa, N., Webb, C. P., Weirich, G., Kishida, T., Zbar, B., Vande Woude, G. F. 1997. Activating mutations for the Met tyrosine kinase receptor in human cancer. *Proceedings of the National Academy of Sciences of the United States of America* 94, 11445-11450.
- Jo, M., Stolz, D. B., Esplen, J. E., Dorko, K., Michalopoulos, G. K., Strom, S. C. 2000. Cross-talk between Epidermal Growth Factor Receptor and c-Met Signal Pathways in Transformed Cells. *Journal of Biological Chemistry* 275, 8806-8811.
- Jones, J. C., Asmuth, J., Baker, S. E., Langhofer, M., Roth, S. I., Hopkinson, S. B. 1994. Hemidesmosomes: extracellular matrix/intermediate filament connectors. *Experimental Cell Research* 213, 1-11.

- Jung, K., Seidel, B., Rudolph, B., Lein, M., Cronauer, M. V., Henke, W., Hampel, G., Schnorr, D., Loening, S. A. 1997. Antioxidant Enzymes In Malignant Prostate Cell Lines and In Primary Cultured Prostatic Cells. *Free Radical Biology and Medicine* 23, 127-133.
- Kajiji, S., Tamura, R. N., Quaranta, V. 1989. A novel integrin (alpha E beta 4) from human epithelial cells suggests a fourth family of integrin adhesion receptors. *The EMBO journal* 8, 673-680.
- Kandouz, M., Nie, D., Pidgeon, G., Krishnamoorthy, S., Maddipati, K., Honn, K. 2003. Platelet-type 12-lipoxygenase activates NF-kappaB in prostate cancer cells. *Prostaglandins Other Lipid Mediat* 71, 189-204.
- Kashyap, T. 2011. Role of $\beta 4$ integrin phosphorylation in human invasive squamous cell carcinoma: regulation of hemidesmosome stability modulates cell migration. *Laboratory investigation* 91, 1414-1426.
- Kennel, S. J., Godfrey, V., Ch'ang, L. Y., Lankford, T. K., Foote, L. J., Makkinje, A. 1992. The beta 4 subunit of the integrin family is displayed on a restricted subset of endothelium in mice. *Journal of Cell Science* 101 (Pt 1), 145-150.
- Kimmel, K. A. 1986. Altered expression in squamous carcinoma cells of an orientation restricted epithelial antigen detected by monoclonal antibody A9. *Cancer research (Baltimore)* 46, 3614-3623.
- Kolonel, L. N. 2001. Fat, meat, and prostate cancer. *Epidemiologic Reviews* 23, 72-81.
- Koster, J., Geerts, D., Favre, B., Borradori, L., Sonnenberg, A. 2003. Analysis of the interactions between BP180, BP230, plectin and the integrin $\alpha 6\beta 4$ important for hemidesmosome assembly. *Journal of Cell Science* 116, 387-399.
- Kreidberg, J. A. 2000. Functions of $\alpha 3\beta 1$ integrin. *Current Opinion in Cell Biology* 12, 548-553.

- Krishnamoorthy, S., Jin, R., Cai, Y., Maddipati, K. R., Nie, D., Pagès, G., Tucker, S. C., Honn, K. V. 2010. 12-Lipoxygenase and the regulation of hypoxia-inducible factor in prostate cancer cells. *Experimental Cell Research* 316, 1706-1715.
- Lacape, G., Daret, D., Crockett, R., Riquaud, M., Larrue, J. 1992. Dual metabolic pathways of 12-HETE in rat aortic smooth muscle cells. *Prostaglandins* 44, 167-176.
- Li, Q. 2012. Tetraspanin CD151 plays a key role in skin squamous cell carcinoma. *Oncogene*
- Limor, R. 2001. A novel form of platelet-type 12-lipoxygenase mRNA in human vascular smooth muscle cells. *Hypertension (Dallas, Tex. 1979)* 38, 864-871.
- Litjens, S. H. M., de Pereda, J. M., Sonnenberg, A. 2006. Current insights into the formation and breakdown of hemidesmosomes. *Trends in Cell Biology* 16, 376-383.
- Liu, B., Khan, W., Hannun, Y., Timar, J., Taylor, J. D., Lundy, S., Butovich, I., Honn, K. 1995. 12(S)-hydroxyeicosatetraenoic acid and 13(S)-hydroxyoctadecadienoic acid regulation of protein kinase C-alpha in melanoma cells: role of receptor-mediated hydrolysis of inositol phospholipids. *Proceedings of the National Academy of Sciences* 92, 9323-9327.
- Liu, B., Maher, R., Hannun, Y., Porter, A. T., Honn, K. 1994a. 12(S)-HETE enhancement of postate tumor cell invasion: selective role of PKC alpha. *J Natl Cancer Inst* 86, 1145-1151.
- Liu, B., Marnett, L. J., Chaudhary, A., Ji, C., Blair, I. A., Johnson, C. R., Diglio, C. A., Honn, K. V. 1994b. Biosynthesis of 12(S)-hydroxyeicosatetraenoic acid by B16 amelanotic melanoma cells is a determinant of their metastatic potential. *Laboratory investigation* 70, 314-323.
- Liu, X., Wang, Q., Yang, G., Marando, C., Koblisch, H. K., Hall, L. M., Fridman, J. S., Behshad, E., Wynn, R., Li, Y., Boer, J., Diamond, S., He, C., Xu, M., Zhuo, J., Yao, W., Newton, R. C., Scherle, P. A. 2011. A Novel Kinase Inhibitor, INCB28060, Blocks c-MET-Dependent

- Signaling, Neoplastic Activities, and Cross-Talk with EGFR and HER-3. *Clinical Cancer Research* 17, 7127-7138.
- Liu, Y.-W., Chen, B.-K., Chen, C.-J., Arakawa, T., Yoshimoto, T., Yamamoto, S., Chang, W.-C. 1997. Epidermal growth factor enhances transcription of human arachidonate 12-lipoxygenase in A431 cells. *Biochimica et Biophysica Acta (BBA) - Lipids and Lipid Metabolism* 1344, 38-46.
- Maddipati, K. R., Zhou, S.-L. 2011. Stability and analysis of eicosanoids and docosanoids in tissue culture media. *Prostaglandins & Other Lipid Mediators* 94, 59-72.
- Mainiero, F., Murgia, C., Wary, K. K., Curatola, A. M., Pepe, A., Blumemberg, M., Westwick, J. K., Der, C. J., Giancotti, F. G. 1997. The coupling of $\alpha 6 \beta 4$ integrin to Ras-MAP kinase pathways mediated by Shc controls keratinocyte proliferation. *EMBO J* 16, 2365-2375.
- Mainiero, F., Pepe, A., Wary, K., Spinardi, L., Mohammadi, M., Schlessinger, J., Giancotti, F. G. 1995. Signal transduction by the $\alpha 6 \beta 4$ integrin: distinct $\beta 2$ subunit sites mediate recruitment of Shc/Grb2 and association with the cytoskeleton of hemidesmosomes. *EMBO J* 14, 4470-4481.
- Mainiero, F., Pepe, A., Yeon, M., Ren, Y., Giancotti, F. G. 1996. The intracellular functions of $\alpha 6 \beta 4$ integrin are regulated by EGF. *The Journal of Cell Biology* 134, 241-253.
- Mariani Costantini, R., Falcioni, R., Battista, P., Zupi, G., Kennel, S. J., Colasante, A., Venturo, I., Curio, C. G., Sacchi, A. 1990. Integrin ($\alpha 6 / \beta 4$) expression in human lung cancer as monitored by specific monoclonal antibodies. *Cancer research (Baltimore)* 50, 6107-6112.

- Mariotti, A., Kedeshian, P. A., Dans, M., Curatola, A. M., Gagnoux-Palacios, L., Giancotti, F. G. 2001. EGF-R signaling through Fyn kinase disrupts the function of integrin $\alpha 6\beta 4$ at hemidesmosomes. *The Journal of Cell Biology* 155, 447-458.
- Marschall, Z. v., Cramer, T., Höcker, M., Finkenzeller, G., Wiedenmann, B., Rosewicz, S. 2001. Dual mechanism of vascular endothelial growth factor upregulation by hypoxia in human hepatocellular carcinoma. *Gut* 48, 87-96.
- McCawley, L. J., O'Brien, P., Hudson, L. G. 1998. Epidermal growth factor (EGF)- and scatter factor/hepatocyte growth factor (SF/HGF)-mediated keratinocyte migration is coincident with induction of matrix metalloproteinase (MMP)-9. *Journal of Cellular Physiology* 176, 255-265.
- Meiners, S., Brinkmann, V., Naundorf, H., Birchmeier, W. 1998. Role of morphogenetic factors in metastasis of mammary carcinoma cells. *Oncogene* 16, 9-20.
- Menter, D. G., Tucker, S. C., Kopetz, S., Sood, A. K., Crissman, J. D., Honn, K. V. 2014. Platelets and cancer: a casual or causal relationship: revisited. *Cancer and Metastasis Reviews* 33, 231-269.
- Merdek, K. D., Yang, X., Taglienti, C. A., Shaw, L. M., Mercurio, A. M. 2007. Intrinsic Signaling Functions of the $\beta 4$ Integrin Intracellular Domain. *Journal of Biological Chemistry* 282, 30322-30330.
- Montero, A., Uda, S., Kelavkar, U., Yoshimura, A., Badr, K. F., Munger, K. A. 2003. Increased 5-lipoxygenase activating protein in immune-mediated experimental nephritis. *Journal of nephrology* 16, 682-690.
- Montesano, R., Matsumoto, K., Nakamura, T., Orci, L. 1991. Identification of a fibroblast-derived epithelial morphogen as hepatocyte growth factor. *Cell* 67, 901-908.

- Nagle, R. B., Hao, J., Knox, J. D., Dalkin, B. L., Clark, V., Cress, A. E. 1995. Expression of hemidesmosomal and extracellular matrix proteins by normal and malignant human prostate tissue. *The American Journal of Pathology* 146, 1498-1507.
- Nakadate, T., Aizu, E., Yamamoto, S., Kato, R. 1986. Some properties of lipoxygenase activities in cytosol and microsomal fractions of mouse epidermal homogenate. *Prostaglandins leukotrienes and medicine* 21, 305-319.
- Nakamura, T., Matsumoto, K. 1992. Hepatocyte growth factor: molecular structure, roles in liver regeneration, and other biological functions. *Crit Rev Oncog* 3, 27-54.
- Natarajan, R., Esworthy, R., Bai, W., Gu, J. L., Wilczynski, S., Nadler, J. 1997. Increased 12-lipoxygenase expression in breast cancer tissues and cells. Regulation by epidermal growth factor. *The journal of clinical endocrinology and metabolism* 82, 1790-1798.
- Natarajan, R., Gu, J. L., Rossi, J., Gonzales, N., Lanting, L., Xu, L., Nadler, J. 1993. Elevated glucose and angiotensin II increase 12-lipoxygenase activity and expression in porcine aortic smooth muscle cells. *Proceedings of the National Academy of Sciences* 90, 4947-4951.
- Needleman, P., Truk, J., Jakschik, B. A., Morrison, A. R., Lefkowitz, J. B. 1986. Arachidonic Acid Metabolism. *Annual Review of Biochemistry* 55, 69-102.
- Nie, D., Che, M., Grignon, D. J., Tang, K., Honn, K. V. 2001. Role of eicosanoids in prostate cancer progression. *Cancer and Metastasis Reviews* 20, 195-206.
- Nie, D., Hillman, G. G., Geddes, T., Tang, K., Pierson, C., Grignon, D. J., Honn, K. V. 1998. Platelet-type 12-lipoxygenase in a human prostate carcinoma stimulates angiogenesis and tumor growth. *Cancer research (Baltimore)* 58, 4047-4051.

- Nie, D., Qiao, Y., Zacharek, A., Krishnamoorthy, S., Jin, R., Tang, K., Guo, Y., Milanini, J., Pages, G., Honn, K. 2006. Mechanisms regulating tumor angiogenesis by 12-Lipoxygenase in prostate cancer cells. *J Biol Chem* 281, 18601-18609.
- Nie, D. H., Honn, K. V. 2002. Cyclooxygenase, lipoxygenase and tumor angiogenesis. *Cellular and molecular life sciences : CMLS* 59, 799-807.
- Niessen, C. M., Hulsman, E. H., Rots, E. S., Sanchez-Aparicio, P., Sonnenberg, A. 1997. Integrin alpha 6 beta 4 forms a complex with the cytoskeletal protein HD1 and induces its redistribution in transfected COS-7 cells. *Molecular biology of the cell* 8, 555-566.
- Niessen, C. M., Raaij-Helmer, M. v. d., Hulsman, E. H., Neut, R. v. d., Jonkman, M. F., Sonnenberg, A. 1996. Deficiency of the integrin beta 4 subunit in junctional epidermolysis bullosa with pyloric atresia: consequences for hemidesmosome formation and adhesion properties. *Journal of Cell Science* 109, 1695-1706.
- Nievers, M., Schaapveld, R., Oomen, L., Fontao, L., Geerts, D., Sonnenberg, A. 1998. Ligand-independent role of the beta 4 integrin subunit in the formation of hemidesmosomes. *J Cell Sci* 111, 1659-1672.
- Nikolopoulos, S. N., Blaikie, P., Yoshioka, T., Guo, W., Giancotti, F. G. 2004. Integrin $\beta 4$ signaling promotes tumor angiogenesis. *Cancer Cell* 6, 471-483.
- Norrish, A. E., Skeaff, C. M., Arribas, G. L. B., Sharpe, S. J., Jackson, R. T. 1999. Prostate cancer risk and consumption of fish oils: A dietary biomarker-based case-control study. *Br J Cancer* 81, 1238-1242.
- O'Connor, K. L., Shaw, L. M., Mercurio, A. M. 1998. Release of cAMP Gating by the $\alpha 6\beta 4$ Integrin Stimulates Lamellae Formation and the Chemotactic Migration of Invasive Carcinoma Cells. *The Journal of Cell Biology* 143, 1749-1760.

- Olivero, M., Rizzo, M., Madeddu, R., Casadio, C., Pennacchietti, S., Nicotra, M. R., Prat, M., Maggi, G., Arena, N., Natali, P. G., Comoglio, P. M., Di Renzo, M. F. 1996. Overexpression and activation of hepatocyte growth factor/scatter factor in human non-small-cell lung carcinomas. *British journal of cancer* 74, 1862-1868.
- Onoda, J. M., Kantak, S. S., Piechocki, M. P., Awad, W., Chea, R., Liu, B., Honn, K. V. 1994. Inhibition of radiation-enhanced expression of integrin and metastatic potential in B16 melanoma cells by a lipoxygenase inhibitor. *Radiation research* 140, 410-418.
- Ottino, P., Taheri, F., Bazan, H. E. 2003. Growth factor-induced proliferation in corneal epithelial cells is mediated by 12(S)-HETE. *Experimental Eye Research* 76, 613-622.
- Owen, K. A., Qiu, D., Alves, J., Schumacher, A. M., Kilpatrick, L. M., Li, J., Harris, J. L., Ellis, V. 2010. Pericellular activation of hepatocyte growth factor by the transmembrane serine proteases matriptase and hepsin, but not by the membrane-associated protease uPA. *Biochemical journal* 426, 219-228.
- Park, M., Dean, M., Kaul, K., Braun, M. J., Gonda, M. A., Vande Woude, G. 1987. Sequence of MET protooncogene cDNA has features characteristic of the tyrosine kinase family of growth-factor receptors. *Proceedings of the National Academy of Sciences* 84, 6379-6383.
- Pearce, M. L., Dayton, S. 1971. Incidence of cancer in men on a diet high in polyunsaturated fat. *The Lancet (British edition)* 1, 464-467.
- Pellegrini, G., De Luca, M., Orecchia, G., Balzac, F., Cremona, O., Savoia, P., Cancedda, R., Marchisio, P. C. 1992. Expression, topography, and function of integrin receptors are severely altered in keratinocytes from involved and uninvolved psoriatic skin. *The Journal of Clinical Investigation* 89, 1783-1795.

- Pepper, M. S., Matsumoto, K., Nakamura, T., Orci, L., Montesano, R. 1992. Hepatocyte growth factor increases urokinase-type plasminogen activator (u-PA) and u-PA receptor expression in Madin-Darby canine kidney epithelial cells. *Journal of Biological Chemistry* 267, 20493-20496.
- Phillis, J. W., Horrocks, L. A., Farooqui, A. A. 2006. Cyclooxygenases, lipoxygenases, and epoxygenases in CNS: Their role and involvement in neurological disorders. *Brain Research Reviews* 52, 201-243.
- Pidgeon, G., Lysaght, J., Krishnamoorthy, S., Reynolds, J., O'Byrne, K., Nie, D., Honn, K. 2007. Lipoxygenase metabolism: roles in tumor progression and survival. *Cancer and Metastasis Reviews* 26, 503-524.
- Pidgeon, G., Tang, K., Cai, Y. L., Piasentin, E., Honn, K. 2003. Overexpression of Platelet-type 12-Lipoxygenase Promotes Tumor Cell Survival by Enhancing α v β 3 and α v β 5 Integrin Expression. *Cancer Research* 63, 4258-4267.
- Piper, P. 1985. Leukotrienes: Potent Mediators of Airway Constriction. *Int Arch Allergy Appl Immunol* 76, 43-48.
- Ponzetto, C., Bardelli, A., Zhen, Z., Maina, F., dalla Zonca, P., Giordano, S., Graziani, A., Panayotou, G., Comoglio, P. M. 1994. A multifunctional docking site mediates signaling and transformation by the hepatocyte growth factor/scatter factor receptor family. *Cell* 77, 261-271.
- Potempa, S., Ridley, A. J. 1998. Activation of Both MAP Kinase and Phosphatidylinositide 3-Kinase by Ras Is Required for Hepatocyte Growth Factor/Scatter Factor–induced Adherens Junction Disassembly. *Molecular biology of the cell* 9, 2185-2200.

- Puri, N., Salgia, R. 2008. Synergism of EGFR and c-Met pathways, cross-talk and inhibition, in non-small cell lung cancer. *Journal of Carcinogenesis* 7
- Rabinovitz, I. 2004. Protein kinase C- α phosphorylation of specific serines in the connecting segment of the β 4 integrin regulates the dynamics of type II hemidesmosomes. *Molecular and cellular biology* 24, 4351-4360.
- Rabinovitz, I., Mercurio, A. M. 1996. The integrin α 6 β 4 and the biology of carcinoma. *Biochemistry and cell biology* 74, 811-821.
- Rabinovitz, I., Toker, A., Mercurio, A. M. 1999. Protein Kinase C-Dependent Mobilization of the α 6 β 4 Integrin from Hemidesmosomes and Its Association with Actin-Rich Cell Protrusions Drive the Chemotactic Migration of Carcinoma Cells. *The Journal of Cell Biology* 146, 1147-1160.
- Ramarli, D., Scupoli, M. T., Fiorini, E., Poffe, O., Brentegani, M., Villa, A., Cecchini, G., Tridente, G., Marchisio, P. C. 1998. Thymocyte Contact or Monoclonal Antibody-Mediated Clustering of α 3 β 1 or α 6 β 4 Integrins Activate Interleukin-6 (IL-6) Transcription Factors (NF- κ B and NF-IL6) and IL-6 Production in Human Thymic Epithelial Cells. *Blood* 92, 3745-3755.
- Raymond, K., Kreft, M., Song, J.-Y., Janssen, H., Sonnenberg, A. 2007. Dual Role of α 6 β 4 Integrin in Epidermal Tumor Growth: Tumor-suppressive Versus Tumor-promoting Function. *Mol. Biol. Cell* 18, 4210-4221.
- Ridley, A. J., Comoglio, P. M., Hall, A. 1995. Regulation of scatter factor/hepatocyte growth factor responses by Ras, Rac, and Rho in MDCK cells. *Molecular and cellular biology* 15, 1110-1122.

- Romano, M., Chen, X. S., Takahashi, Y., Yamamoto, S., Funk, C. D., Serhan, C. N. 1993. Lipoxin synthase activity of human platelet 12-lipoxygenase. *Biochemical journal* 296 (Pt 1), 127-133.
- Rong, S., Segal, S., Anver, M., Resau, J., Vande Woude, G. F. 1994. Invasiveness and metastasis of NIH 3T3 cells induced by Met-hepatocyte growth factor/scatter factor autocrine stimulation. *Proc Natl Acad Sci USA* 91, 4731-4735.
- Rousselle, P., Lunstrum, G. P., Keene, D. R., Burgeson, R. E. 1991. Kalinin: an epithelium-specific basement membrane adhesion molecule that is a component of anchoring filaments. *The Journal of Cell Biology* 114, 567-576.
- Samuelsson, B. 1983. Leukotrienes: mediators of immediate hypersensitivity reactions and inflammation. *Science (New York, N.Y.)* 220, 568-575.
- Santoro, M. M., Gaudino, G., Marchisio, P. C. 2003. The MSP Receptor Regulates $\alpha 6\beta 4$ and $\alpha 3\beta 1$ Integrins via 14-3-3 Proteins in Keratinocyte Migration. *Developmental Cell* 5, 257-271.
- Savoia, P., Trusolino, L., Pepino, E., Cremona, O., Marchisio, P. C. 1993. Expression and topography of integrins and basement membrane proteins in epidermal carcinomas: basal but not squamous cell carcinomas display loss of alpha 6 beta 4 and BM-600/nicein. *Journal of investigative dermatology* 101, 352-358.
- Schmidt, C., Bladt, F., Goedecke, S., Brinkmann, V., Zschiesche, W., Sharpe, M., Gherardi, E., Birchmeier, C. 1995. Scatter factor/hepatocyte growth factor is essential for liver development. *Nature (London)* 373, 699-702.
- Schmidt, L., Duh, F. M., Chen, F., Kishida, T., Glenn, G., Choyke, P., Scherer, S. W., Zhuang, Z., Lubensky, I., Dean, M., Allikmets, R., Chidambaram, A., Bergerheim, U. R., Feltis, J. T., Casadevall, C., Zamarron, A., Bernues, M., Richard, S., Lips, C. J., Walther, M. M., Tsui,

- L. C., Geil, L., Orcutee, M. L., Stackhouse, T., Lipan, J., Slife, L., Brauch, H., Decker, J., Niehans, G., Hughson, M. D., Moch, H., Storkel, S., Lerman, M. I., Linehan, W. M., Zbar, B. 1997. Germline and somatic mutations in the tyrosine kinase domain of the MET proto-oncogene in papillary renal carcinomas. *Nature genetics* 16, 68-73.
- Schwartz, M. A. 1997. Integrins, oncogenes, and anchorage independence. *The Journal of Cell Biology* 139, 575-578.
- Sekulić, A., Hudson, C. C., Homme, J. L., Yin, P., Otterness, D. M., Karnitz, L. M., Abraham, R. T. 2000. A Direct Linkage between the Phosphoinositide 3-Kinase-AKT Signaling Pathway and the Mammalian Target of Rapamycin in Mitogen-stimulated and Transformed Cells. *Cancer Research* 60, 3504-3513.
- Serhan, C. N. 1994. Lipoxin biosynthesis and its impact in inflammatory and vascular events. *Biochimica et Biophysica Acta (BBA) - Lipids and Lipid Metabolism* 1212, 1-25.
- Shattuck, D. L., Miller, J. K., Carraway, K. L., Sweeney, C. 2008. Met Receptor Contributes to Trastuzumab Resistance of Her2-Overexpressing Breast Cancer Cells. *Cancer Research* 68, 1471-1477.
- Shaw, L. M. 2001. Identification of Insulin Receptor Substrate 1 (IRS-1) and IRS-2 as Signaling Intermediates in the $\alpha 6\beta 4$ Integrin-Dependent Activation of Phosphoinositide 3-OH Kinase and Promotion of Invasion. *Molecular and cellular biology* 21, 5082-5093.
- Shaw, L. M., Rabinovitz, I., Wang, H. H. F., Toker, A., Mercurio, A. M. 1997. Activation of Phosphoinositide 3-OH Kinase by the $[\alpha 6][\beta 4]$ Integrin Promotes Carcinoma Invasion. *Cell* 91, 949-960.
- Shimizu, T., Wolfe, L. S. 1990. Arachidonic acid cascade and signal transduction. *Journal of neurochemistry* 55, 1-15.

- Shweiki, D., Itin, A., Soffer, D., Keshet, E. 1992. Vascular endothelial growth factor induced by hypoxia may mediate hypoxia-initiated angiogenesis. *Nature (London)* 359, 843-845.
- Soman, N. R., Correa, P., Ruiz, B. A., Wogan, G. N. 1991. The TPR-MET oncogenic rearrangement is present and expressed in human gastric carcinoma and precursor lesions. *Proceedings of the National Academy of Sciences* 88, 4892-4896.
- Sonnenberg, A., Calafat, J., Janssen, H., Daams, H., van der Raaij-Helmer, L. M., Falcioni, R., Kennel, S. J., Aplin, J. D., Baker, J., Loizidou, M., Garrod, D. 1991. Integrin alpha 6/beta 4 complex is located in hemidesmosomes, suggesting a major role in epidermal cell-basement membrane adhesion. *The Journal of Cell Biology* 113, 907-917.
- Sonnenberg, A., Linders, C. J., Daams, J. H., Kennel, S. J. 1990. The alpha 6 beta 1 (VLA-6) and alpha 6 beta 4 protein complexes: tissue distribution and biochemical properties. *Journal of Cell Science* 96 (Pt 2), 207-217.
- Spector, A. A., Gordon, J. A., Moore, S. A. 1988. Hydroxyeicosatetraenoic acids (HETEs). *Progress in Lipid Research* 27, 271-323.
- Spinardi, L., Einheber, S., Cullen, T., Milner, T. A., Giancotti, F. G. 1995. A recombinant tail-less integrin beta 4 subunit disrupts hemidesmosomes, but does not suppress alpha 6 beta 4-mediated cell adhesion to laminins. *The Journal of Cell Biology* 129, 473-487.
- Stoker, M., Gherardi, E., Perryman, M., Gray, J. 1987. Scatter factor is a fibroblast-derived modulator of epithelial cell mobility. *Nature* 327, 239-242.
- Suzuki, Y., Kondo, Y., Himeno, S., Nemoto, K., Akimoto, M., Imura, N. 2000. Role of antioxidant systems in human androgen-independent prostate cancer cells. *The Prostate* 43, 144-149.

- Szekeres, C. K., Tang, K., Trikha, M., Honn, K. V. 2000. Eicosanoid Activation of Extracellular Signal-regulated Kinase1/2 in Human Epidermoid Carcinoma Cells. *Journal of Biological Chemistry* 275, 38831-38841.
- Szekeres, C. K., Trikha, M., Honn, K. V. 2002. 12(S)-HETE, pleiotropic functions, multiple signaling pathways. *Advances in experimental medicine and biology* 507, 509-515.
- Tang, D., Diglio, C., Bazaz, R., Honn, K. 1995. Transcriptional activation of endothelial cell integrin alpha v by protein kinase C activator 12(S)-HETE. *J Cell Sci* 108, 2629-2644.
- Tang, D. G., Chen, Y. Q., Honn, K. V. 1996. Arachidonate lipoxygenases as essential regulators of cell survival and apoptosis. *Proceedings of the National Academy of Sciences* 93, 5241-5246.
- Tang, D. G., Honn, K. V. 1994. 12-Lipoxygenase, 12(S)-HETE, and Cancer Metastasis. *Annals of the New York Academy of Sciences* 744, 199-215.
- Tang, D. G., Timar, J., Grossi, I. M., Renaud, C., Kimler, V. A., Diglio, C. A., Taylor, J. D., Honn, K. V. 1993. The Lipoxygenase Metabolite, 12(S)-HETE, Induces a Protein Kinase C-Dependent Cytoskeletal Rearrangement and Retraction of Microvascular Endothelial Cells. *Experimental Cell Research* 207, 361-375.
- Tang, K., Finley, R. L., Nie, D., Honn, K. V. 2000. Identification of 12-Lipoxygenase Interaction with Cellular Proteins by Yeast Two-Hybrid Screening†. *Biochemistry* 39, 3185-3191.
- Tang, K., Nie, D., Cai, Y., Honn, K. V. 1999. The [beta]4 Integrin Subunit Rescues A431 Cells from Apoptosis through a PI3K/Akt Kinase Signaling Pathway. *Biochemical and Biophysical Research Communications* 264, 127-132.
- Thiery, J. P. 2002. Epithelial-mesenchymal transitions in tumour progression. *Nature reviews. Cancer* 2, 442-454.

- Timár, J., Raso, E., Honn, K. V., Hagmann, W. 1999. 12-lipoxygenase expression in human melanoma cell lines. *Advances in experimental medicine and biology* 469, 617-622.
- Timár, J., Silletti, S., Bazaz, R., Raz, A., Honn, K. V. 1993. Regulation of Melanoma-Cell Motility by the Lipoxygenase Metabolite 12(S)-HETE. *Int J cancer* 55, 1003-1010.
- Trusolino, L., Bertotti, A., Comoglio, P. M. 2001. A Signaling Adapter Function for $\alpha 6\beta 4$ Integrin in the Control of HGF-Dependent Invasive Growth. *Cell* 107, 643-654.
- Trusolino, L., Cavassa, S., ANGELINI, P., ANDÒ, M., BERTOTTI, A., COMOGLIO, P. M., BOCCACCIO, C. 2000. HGF/scatter factor selectively promotes cell invasion by increasing integrin avidity. *The FASEB Journal* 14, 1629-1640.
- Tucker, S. C., Honn, K. V. 2013. Emerging targets in lipid-based therapy. *Biochemical pharmacology* 85, 673-688.
- Uehara, Y., Minowa, O., Mori, C., Shiota, K., Kuno, J., Noda, T., Kitamura, N. 1995. Placental defect and embryonic lethality in mice lacking hepatocyte growth factor/scatter factor. *Nature (London)* 373, 702-705.
- Uematsu, J., Nishizawa, Y., Sonnenberg, A., Owaribe, K. 1994. Demonstration of type II hemidesmosomes in a mammary gland epithelial cell line, BMGE-H. *Journal of biochemistry (Tokyo)* 115, 469-476.
- Ulbricht, B., Hagmann, W., Ebert, W., Spiess, E. 1996. Differential secretion of cathepsins B and L from normal and tumor human lung cells stimulated by 12(S)-hydroxy-eicosatetraenoic acid. *Experimental Cell Research* 226, 255-263.
- Wan, X., Kim, S. Y., Guenther, L. M., Mendoza, A., Briggs, J., Yeung, C., Currier, D., Zhang, H., Mackall, C., Li, W. J., Tuan, R. S., Deyrup, A. T., Khanna, C., Helman, L. 2009. Beta4

- integrin promotes osteosarcoma metastasis and interacts with ezrin. *Oncogene* 28, 3401-3411.
- Wang, R., Kobayashi, R., Bishop, J. M. 1996. Cellular adherence elicits ligand-independent activation of the Met cell-surface receptor. *Proceedings of the National Academy of Sciences* 93, 8425-8430.
- Weidner, K. M., Di Cesare, S., Sachs, M., Brinkmann, V., Behrens, J., Birchmeier, W. 1996. Interaction between Gab1 and the c-Met receptor tyrosine kinase is responsible for epithelial morphogenesis. *Nature (London)* 384, 173-176.
- Wilhelmsen, K., Litjens, S. H., Kuikman, I., Margadant, C., van Rheenen, J., Sonnenberg, A. 2007. Serine phosphorylation of the integrin beta4 subunit is necessary for epidermal growth factor receptor induced hemidesmosome disruption. *Molecular biology of the cell* 18, 3512-3522.
- Wojcik, E. J., Sharifpoor, S., Miller, N. A., Wright, T. G., Watering, R., Tremblay, E. A., Swan, K., Mueller, C. R., Elliot, B. E. 2006. A novel activating function of c-Src and Stat3 on HGF transcription in mammary carcinoma cells. *Oncogene* 25, 2773-2784.
- Wong, A. S., Pelech, S. L., Woo, M. M., Yim, G., Rosen, B., Ehlen, T., Leung, P. C., Auersperg, N. 2001a. Coexpression of hepatocyte growth factor-Met: an early step in ovarian carcinogenesis? *Oncogene* 20, 1318-1328.
- Wong, B. C. Y., Wang, W. P., Cho, C. H., Fan, X. M., Lin, M. C. M., Kung, H. F., Lam, S. K. 2001b. 12-Lipoxygenase inhibition induced apoptosis in human gastric cancer cells. *Carcinogenesis* 22, 1349-1354.
- Wynder, E. L., Mabuchi, K., Whitmore, W. F. J. 1971. Epidemiology of cancer of the prostate. *Cancer* 28, 344-360.

- Yamamoto, S. 1992. Mammalian lipoxygenases: molecular structures and functions. *Biochimica et biophysica acta* 1128, 117-131.
- Yang, B., Ren, X.-L., Fu, Y.-Q., Gao, J.-L., Li, D. 2014. Ratio of n-3/n-6 PUFAs and risk of breast cancer: a meta-analysis of 274135 adult females from 11 independent prospective studies. *BMC Cancer* 14, 105.
- Yang, X., Dutta, U., Shaw, L. M. 2010. SHP2 Mediates the Localized Activation of Fyn Downstream of the $\alpha 6\beta 4$ Integrin To Promote Carcinoma Invasion. *Molecular and cellular biology* 30, 5306-5317.
- Yoshimoto, T. 1982. Arachidonate 12-lipoxygenase of porcine leukocyte with activity for 5-hydroxyeicosatetraenoic acid. *Biochimica et biophysica acta* 713, 638-646.
- Yoshimoto, T., Arakawa, T., Hada, T., Yamamoto, S., Taskahashi, E. 1992. Structure and chromosomal localization of human arachidonate 12-lipoxygenase gene. *The Journal of biological chemistry* 267, 24805-24809.
- Yoshioka, T., Otero, J., Chen, Y., Kim, Y.-M., Koutcher, J. A., Satagopan, J., Reuter, V., Carver, B., de Stanchina, E., Enomoto, K., Greenberg, N. M., Scardino, P. T., Scher, H. I., Sawyers, C. L., Giancotti, F. G. 2013. $\beta 4$ Integrin signaling induces expansion of prostate tumor progenitors. *The Journal of Clinical Investigation* 0, 0-0.
- Yu, P. T., Babicky, M., Jaquish, D., French, R., Marayuma, K., Mose, E., Niessen, S., Hoover, H., Shields, D., Cheresch, D., Cravatt, B. F., Lowy, A. M. 2012. The RON-receptor regulates pancreatic cancer cell migration through phosphorylation-dependent breakdown of the hemidesmosome. *International journal of cancer* 131, 1744-1754.
- Zahir, N., Lakins, J. N., Russell, A., Ming, W., Chatterjee, C., Rozenberg, G. I., Marinkovich, M. P., Weaver, V. M. 2003. Autocrine laminin-5 ligates $\alpha 6\beta 4$ integrin and activates RAC and

NFκB to mediate anchorage-independent survival of mammary tumors. *The Journal of Cell Biology* 163, 1397-1

ABSTRACT**A NOVEL FUNCTION FOR 12-LIPOXYGENASE IN C-MET AND INTEGRIN β 4 AXIS CROSSTALK**

by

ELIZABETH TOVAR

August 2014

Advisor: Dr. Kenneth V. Honn**Major:** Cancer Biology**Degree:** Doctor of Philosophy

Cancer cell metastasis is the single most threatening occurrence of tumor progression and predicts patient prognosis as well as survival. Invasion can be regulated by the Met receptor tyrosine kinase (c-Met), integrin β 4 (β 4), and the lipid enzyme, 12-Lipoxygenase (12-LOX). Therefore we sought to determine if β 4, c-MET and 12-LOX comprise a signaling axis. c-Met is implicated in cancer cell dissemination through regulation of invasion in EMT where cell-cell junctions are disturbed to allow motility. Furthermore, β 4 promotes cellular adhesion to the extracellular matrix through hemidesmosomes. However, the homeostatic signaling functions of β 4's cytoplasmic tail can be hijacked by growth factor receptors during tumor growth to promote tumor cell survival and metastasis. β 4 interacts with 12-LOX, an enzyme that metabolizes arachidonic acid to yield 12(S)-HETE, a bioactive lipid that also promotes invasion, tumor growth, and resistance to apoptosis. Our findings reveal that c-Met and β 4 interact in a cell type and condition specific manner. HGF treatment led to β 4 phosphorylation, disruption of the c-Met interaction, and concomitant 12-LOX recruitment. However, despite 12-LOX recruitment, LC-MS analyses showed that HGF stimulation did not lead to increased 12(S)-HETE production. 12-LOX knockdown with shRNA abolished HGF-induced β 4 phosphorylation and downstream signaling,

leading to decreased HGF-induced invasion and cell scattering. Inhibition of $\beta 4$ interaction with 12-LOX using specifically designed peptides recapitulated the 12-LOX knockdown phenotype. Additionally, inhibition of 12-LOX led to decreased HGF-induced invasion. This is the first demonstration that 12-LOX may have a novel function in modulating c-MET and $\beta 4$ signaling through a scaffolding function and outlines a clear rationale to target all three proteins in cancer therapeutics.

AUTOBIOGRAPHICAL STATEMENT**ELIZABETH TOVAR**

Elizabeth was born and raised in Charlotte, Michigan. Elizabeth graduated from Charlotte High School in 2004 and attended Ferris State University in Big Rapids, Michigan for her undergraduate studies. There she earned a Bachelor of Science in Biotechnology and a Bachelor of Arts in Biochemistry. To fulfill the Biotechnology degree requirements, Elizabeth interned at Neogen Corporation in Lansing, Michigan under the guidance of Dr. Paul Satoh during the summer of 2008. At Ferris, Elizabeth participated in the Honors Program and was a member of several organizations including the professional sorority Lambda Kappa Sigma and the Delta Nu Alpha Biotechnology Club. She received a few notable recognitions including the Residential Life Scholarship, the Academic Achievement Award, the S-STEM scholarship, the Dean's Academic Ability Scholarship in Biotechnology, and the Outstanding Graduate in Biology Award. Elizabeth joined the Cancer Biology Program at the Wayne State University School of Medicine in the fall of 2009 and began her dissertation work with Dr. Kenneth V. Honn in the spring of 2010. She has been supported by the Rumble Fellowship, the T32 Training Grant, and the Cancer Biology Program during her time at Wayne.